



MINISTERIO
DE INDUSTRIA, ENERGÍA
Y TURISMO

DIRECCIÓN GENERAL DE INDUSTRIA Y
DE LA PEQUEÑA Y MEDIANA EMPRESA
SUBDIRECCIÓN GENERAL DE
CALIDAD Y SEGURIDAD INDUSTRIAL



TA1-E9-00.1865

Página / Page 1 / 2

COMUNICACIÓN / COMMUNICATION:

Concerniente a (1): LA CONCESION DE HOMOLOGACIÓN
~~LA EXTENSIÓN DE HOMOLOGACIÓN~~
~~LA DENEGACIÓN DE HOMOLOGACIÓN~~
~~LA RETIRADA DE HOMOLOGACIÓN~~
EL CESE DEFINITIVO DE PRODUCCIÓN

Concerning (1): APPROVAL GRANTED
~~APPROVAL EXTENDED~~
~~APPROVAL REFUSED~~
~~APPROVAL WITHDRAWN~~
PRODUCTION DEFINITELY DISCONTINUED

de un tipo de luz especial de aviso para automóviles en aplicación del Reglamento N° 65.
of a type of special warning lamp for motor vehicles, pursuant to Regulation No.65.

N° de homologación / Approval No: TA1-E9-00.1865

Extensión n° / Extension No.: ----

1. Luz especial de aviso / ~~rotativa~~ / luz estacionaria intermitente / ~~luz direccional intermitente~~ / barra completa / ~~media barra~~ / azul / amarillo auto / rojo (1) / *Special warning lamp / ~~rotating~~ / stationary flashing lamp / ~~directional flashing lamp~~ / complete bar / ~~half bar~~ / blue / amber / red (1)*
2. Luz especial de aviso con un / ~~dos~~ nivel(es) de intensidad (1) / *Special warning lamp has one / ~~two~~ level(s) of intensity (1)*
Luz especial de aviso formada por unidades separadas / *Special warning lamp consists of separate units*
3. Para las luces especiales de aviso con dos niveles de intensidad, sistema empleado para obtener intensidad reforzada de día / *For special warning lamps having two levels of intensity, indicate the system used to obtain increased intensity at daytime. :-----*
4. Fuente de luz utilizada / *Used light source*
 - categoría de lámpara de incandescencia / *category of filament lamp:* o/or
 - lámpara de descarga de gas / *gas discharge light source:* si / no - ~~yes~~/no o/or
 - LED: si / no - ~~yes~~/no o/orMódulo de fuente de luz / *Light source module:* si / no - ~~yes~~/no
Código específico de identificación del módulo de fuente de luz / *Light source module specific identification code:* ---
5. Tensión nominal de la luz especial de aviso / *Rated voltage of special warning lamp:* 12V/24V
6. Marca o denominación comercial / *Trade name or mark:* FordaLite
Tipo / *Type:* WA-027C2A-MZ-N

(1) Táchese lo que no proceda / *Strike out what does not apply*



MINISTERIO
DE INDUSTRIA, ENERGÍA
Y TURISMO

DIRECCIÓN GENERAL DE INDUSTRIA Y
DE LA PEQUEÑA Y MEDIANA EMPRESA

SUBDIRECCIÓN GENERAL DE
CALIDAD Y SEGURIDAD INDUSTRIAL



TA1-E9-00.1865

Página / Page 2 / 2

7. Nombre y dirección del fabricante / *Manufacturer's name and address:*
Guangzhou Forda Signal Equipment Co. Ltd.
Building C West side of Dongfeng
High Auto City Huadu District,
Guangzhou, China
8. Cuando proceda, nombre y dirección del representante del fabricante / *If applicable, name and address of manufacturer's representative:-----*
9. Presentado a homologación el / *Submitted for approval on:* 20/09/2016
10. Servicio técnico encargado de los ensayos de homologación / *Technical service responsible for approval test:*
IDIADA
11. Fecha del informe realizado por dicho servicio / *Date of report issued by that service:* 27/09/2016
12. Número del informe realizado por dicho servicio / *Number of report issued by that service:* PC16090293
13. La homologación se concede/~~deniega~~/~~extiende~~/~~retira~~ ⁽¹⁾ / *Approval granted* / ~~refused~~ / ~~extended~~ / ~~withdrawn~~ ⁽¹⁾
14. Motivo(s) de la extensión (si procede) / *Reason(s) of extension (if applicable): ---*
15. Lugar / *Place:* Madrid
16. Fecha / *Date:* Ver firma electrónica / *see electronic signature*
17. Firma / *Signature:*

EL SUBDIRECTOR GENERAL DE CALIDAD Y SEGURIDAD INDUSTRIAL
Resolución P.D. 25-10-2012
18. Anexa a esta comunicación se encuentra la lista de documentos que constituyen el fichero de homologación depositados en el Servicio administrativo que la concede; estos documentos se pueden obtener previa demanda / *The list of documents filed with the administration service which has granted approval and available on request is annexed to this communication.*
 - Informe del ensayo / *Test report*
 - Documentación suministrada por el fabricante / *Documentation supplied by the manufacturer*

(1) Táchese lo que no proceda / *Strike out what does not apply*

INFORME N° / REPORT No. PC16090293**RELATIVO A LA HOMOLOGACIÓN DE LUCES ESPECIALES DE AVISO PARA AUTOMÓVILES
SEGÚN EL REGLAMENTO ECE 65.00 / CONCERNING THE APPROVAL OF SPECIAL WARNING LIGHTS
FOR MOTOR VEHICLES ACCORDING TO REGULATION ECE 65.00**

Nombre y dirección del fabricante /
Manufacturer's name and address : Guangzhou Forda Signal Equipment Co. Ltd.
Building C West side of Dongfeng
High Auto City Huadu District,
Guangzhou, China

Marca comercial / *Trade mark* : FordaLite

Tipo / *Type* : WA-027C2A-MZ-N

Lugar y fecha de emisión del informe /
Place and date of test report issue : L'Albornar, Santa Oliva (Tarragona)
27/09/2016

CONCLUSIONES / CONCLUSIONS: El dispositivo presentado **CUMPLE** las prescripciones relativas a la homologación de luces especiales de aviso para automóviles en aplicación del Reglamento N° 65.00 ECE, según se detalla en el anexo que se adjunta a este informe / *This device **FULFILLS** the prescriptions with regard to the approval of special warning lights in application of Regulation No.65.00 ECE, as detailed in the annex to this report.*

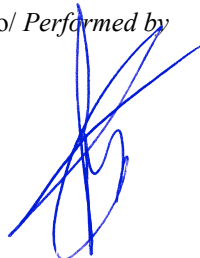
Realizado/ *Performed by*

Joan Fonts Sala
INGENIERO DE ENSAYOS
TEST ENGINEER

V. B°./ *Revised by:*

Ramon Santafè Guiu
JEFE DE DEPARTAMENTO
DEPARTMENT MANAGER

* LOS RESULTADOS PRESENTADOS SE REFIEREN ÚNICAMENTE A LA MUESTRA ENSAYADA.
THE PRESENTED RESULTS REFER ONLY TO THE TESTED SAMPLE

* QUEDA TERMINANTEMENTE PROHIBIDA LA REPRODUCCIÓN PARCIAL DE ESTE INFORME SIN PERMISO EXPRESO DE IDIADA.
THE PARTIAL REPRODUCTION OF THIS REPORT WITHOUT THE PERMISSION OF IDIADA IS COMPLETELY FORBIDDEN

ANEXO AL INFORME**ANNEX TO THE REPORT****RELATIVO A LA HOMOLOGACIÓN DE LUCES ESPECIALES DE AVISO PARA AUTOMÓVILES
SEGÚN EL REGLAMENTO ECE 65.00 / CONCERNING THE APPROVAL OF SPECIAL WARNING LIGHTS
FOR MOTOR VEHICLES ACCORDING TO REGULATION ECE 65.00**

Nombre y dirección del fabricante / <i>Manufacturer's name and address</i>	:	Guangzhou Forda Signal Equipment Co. Ltd. Building C West side of Dongfeng High Auto City Huadu District, Guangzhou, China
Marca comercial / <i>Trade mark</i>	:	FordaLite
Tipo / <i>Type</i>	:	WA-027C2A-MZ-N
Variantes / <i>Variants</i>	:	Ver documentación del fabricante / <i>See manufacturer's documentation</i>
Identificación de las muestras / <i>Sample identification</i>	:	HTC-1609/92
Luz especial de aviso / <i>Special warning lamp</i>	:	Rotativa / <i>Rotating</i> Luz estacionaria intermitente / <i>Stationary flashing lamp</i> Luz direccional intermitente / <i>Directional flashing lamp</i> Barra completa / <i>Complete bar</i> Media barra / <i>Half bar</i>
Categoría / <i>Category</i>	:	T
Clase / <i>Class</i>	:	1 /2
Fuente luminosa / <i>Light source</i>	:	LEDS
Color / <i>Colour</i>	:	Ambar / <i>Amber</i>
Tensión nominal / <i>Rated voltage</i>	:	12 / 24 V
Módulo de fuente luminosa / <i>Light source module</i>	:	si-yes / no-no
Código específico de identificación del módulo de fuente luminosa / <i>Light source module specific identification code:</i>	:	---

* LOS RESULTADOS PRESENTADOS SE REFIEREN UNICAMENTE A LA MUESTRA ENSAYADA.
THE PRESENTED RESULTS REFER ONLY TO THE TESTED SAMPLE

* QUEDA TERMINANTEMENTE PROHIBIDA LA REPRODUCCION PARCIAL DE ESTE INFORME SIN PERMISO EXPRESO DE IDIADA.
THE PARTIAL REPRODUCTION OF THIS REPORT WITHOUT THE PERMISSION OF IDIADA IS COMPLETELY FORBIDDEN

MARCAJE / MARKING

Marcaje / Marking	CORRECTO / CORRECT
----------------------	-------------------------------

ESPECIFICACIONES GENERALES / GENERAL SPECIFICATIONS

Resistencia a las vibraciones / <i>Vibration endurance</i>	CORRECTO / CORRECT
No posibilidad de desajuste una vez la luz ha sido instalada correctamente en el vehículo / <i>No maladjustment is possible after the light has been mounted correctly on the vehicle (5.2)</i>	CORRECTO / CORRECT
Tiene que conectarse directamente a la red de voltaje suministrado por el coche por conexión directa o conectores habituales (por ejemplo, el enchufe del encendedor) / <i>Shall be powered directly from the voltage supply network of the vehicle by direct connection or usual connectors (e.g. cigarette lighter plug) (5.2.1.)</i>	CORRECTO / CORRECT
Cuando se use una fuente luminosa no reemplazable, ésta debe estar fijada de modo permanente sobre el dispositivo / <i>When a non-replaceable light source is used it shall be permanently fixed to the special warning lamp (5.3)</i>	CORRECTO / CORRECT
En el caso que el sistema use una fuente de alimentación especial, o una fuente de alimentación dedicada, o un mecanismo de control de la fuente luminosa forma parte de la luz especial de aviso / <i>In the case of a system that uses a special power supply, or a dedicated power supply, or light source control gear is part of special warning lamp (5.5)</i>	CORRECTO / CORRECT
Frecuencia f , tiempo de encendido t_H y tiempo de apagado t_D medidos a temperatura ambiente de $+23^{\circ}\text{C} \pm 5^{\circ}\text{C}$ y con tensiones entre el 90% y el 115% de la tensión nominal / <i>Frequency f, "on" time t_H and "off" time t_D measured at an ambient temperature of $+23^{\circ}\text{C} \pm 5^{\circ}\text{C}$ and with voltages between 90% and 115% of the rated voltage. (5.6)</i>	CORRECTO / CORRECT
El encendido y el funcionamiento correcto de la luz especial de aviso deberán estar asegurados a temperaturas entre -20°C y $+50^{\circ}\text{C}$. La frecuencia está comprendida entre 2 y 4 Hz un minuto después de aplicar una tensión igual al 90% de la tensión nominal. / <i>Starting and correct functioning of the special warning lamp remains assured at temperature between -20°C and $+50^{\circ}\text{C}$. Frequency remains between 2 and 4 Hz one minute after a voltage equal to 90 % of the rated voltage is applied (5.6)</i>	CORRECTO / CORRECT
El volumen de agua acumulado después del ensayo no excede 2 cm^3 / <i>Accumulated volume of water after the test does not exceed 2 cm^3 (5.6-Annex 4)</i>	CORRECTO / CORRECT
Una luz especial de aviso rotativa o intermitente de categoría T puede emitir luz de varios colores. En este caso se deberán cumplir todos los requisitos para cada color por separado sobre el rango angular completo especificado. La activación de más de un color al mismo tiempo está prohibido (5.8) / <i>A rotating or flashing special warning lamp device of Category T may emit light of several colours. In this case all the requirements shall be met for each colour separately over the full angular range specified. The activation of more than one colour at the same time shall be prohibited.(5.8)</i>	NO APLICABLE / NOT APPLICABLE

* LOS RESULTADOS PRESENTADOS SE REFIEREN ÚNICAMENTE A LA MUESTRA ENSAYADA.
THE PRESENTED RESULTS REFER ONLY TO THE TESTED SAMPLE

* QUEDA TERMINANTEMENTE PROHIBIDA LA REPRODUCCION PARCIAL DE ESTE INFORME SIN PERMISO EXPRESO DE IDIADA.
THE PARTIAL REPRODUCTION OF THIS REPORT WITHOUT THE PERMISSION OF IDIADA IS COMPLETELY FORBIDDEN

En el caso de luces especiales de aviso homologadas en virtud del presente Reglamento, no será posible para el usuario activar grupos de varios flashes (patrones de destello), que no se ajusten a los requisitos establecidos en el párrafo 6 del Anexo 5 (5.9) / <i>In the case of special warning lamps approved under this Regulation, it shall be not possible for the user to activate groups of several flashes (flash patterns), which do not conform to the requirements in paragraph 6 of Annex 5.(5.9)</i>	CORRECTO / CORRECT
--	-------------------------------

MÓDULO DE FUENTE LUMINOSA / LIGHT SOURCE MODULE

Ajuste correcto / <i>Correct fitting (5.4.1)</i>	NO APLICABLE / NOT APPLICABLE
Resistente a la manipulación / <i>Tamperproof (5.4.2)</i>	NO APLICABLE / NOT APPLICABLE

ESPECIFICACIONES COLORIMÉTRICAS / COLORIMETRIC SPECIFICATIONS

Coordenadas cromáticas / <i>Cromatic co-ordinates</i> (eje de referencia / <i>reference axis</i>)		MUESTRA A / <i>SAMPLE A</i>		MUESTRA B / <i>SAMPLE B</i>	
		Lente 1 / <i>Lens 1</i>	Lente 2 / <i>Lens 2</i>	Lente 1 / <i>Lens 1</i>	Lente 2 / <i>Lens 2</i>
x		0.580	---	0.580	---
y	$y \leq x - 0.120$	0.406	---	0.406	---
	$y \geq 0.390$				
	$y \geq 0.790 - 0.670x$				
z		0.014	---	0.014	---

ESPECIFICACIONES FOTOMÉTRICAS / PHOTOMETRIC SPECIFICATIONS
MEDIDAS DE FRECUENCIA / FREQUENCY MEASUREMENTS (T = 23°C ± 5°C)

	Frecuencia / <i>Frequency</i> (2 Hz ≤ f ≤ 4 Hz)	
	MUESTRA A / <i>SAMPLE A</i>	MUESTRA B / <i>SAMPLE B</i>
Tensión nominal / <i>Nominal voltage</i>	2.08 Hz	2.08 Hz
90% tensión nominal / <i>90% nominal voltage</i>	2.08 Hz	2.08 Hz
115% tensión nominal / <i>115% nominal voltage</i>	2.08 Hz	2.08 Hz

* LOS RESULTADOS PRESENTADOS SE REFIEREN ÚNICAMENTE A LA MUESTRA ENSAYADA.
THE PRESENTED RESULTS REFER ONLY TO THE TESTED SAMPLE

* QUEDA TERMINANTEMENTE PROHIBIDA LA REPRODUCCION PARCIAL DE ESTE INFORME SIN PERMISO EXPRESO DE IDIADA.
THE PARTIAL REPRODUCTION OF THIS REPORT WITHOUT THE PERMISSION OF IDIADA IS COMPLETELY FORBIDDEN

MEDIDAS DEL TIEMPO DE ENCENDIDO (t_H) / "ON" TIME MEASUREMENTS (t_H)

(T = 23°C ± 5°C)

	Tiempo de encendido (t_H) ≤ 0.4 / f / "ON" time (t_H) ≤ 0.4 / f	
	MUESTRA A / SAMPLE A	MUESTRA B / SAMPLE B
Tensión Nominal / <i>Rated voltage</i>	$t_H=184 \text{ ms} \leq 0.4 / f= 192 \text{ ms}$	$t_H=184 \text{ ms} \leq 0.4 / f= 192 \text{ ms}$
90% tensión / <i>90% voltage</i>	$t_H=184 \text{ ms} \leq 0.4 / f= 192 \text{ ms}$	$t_H=184 \text{ ms} \leq 0.4 / f= 192 \text{ ms}$
115% tensión / <i>115% voltage</i>	$t_H=184 \text{ ms} \leq 0.4 / f= 192 \text{ ms}$	$t_H=184 \text{ ms} \leq 0.4 / f= 192 \text{ ms}$

MEDIDAS DEL TIEMPO DE APAGADO (t_D) / "OFF" TIME MEASUREMENTS (t_D)

(T = 23°C ± 5°C)

	Tiempo de apagado (t_D) ≥ 0.1s / "OFF" time (t_D) ≥ 0.1s	
	MUESTRA A / SAMPLE A	MUESTRA B / SAMPLE B
Tensión Nominal / <i>Rated voltage</i>	$t_D= 296 \text{ ms} \geq 0.1\text{s}$	$t_D= 296 \text{ ms} \geq 0.1\text{s}$
90% tensión / <i>90% voltage</i>	$t_D= 296 \text{ ms} \geq 0.1\text{s}$	$t_D= 296 \text{ ms} \geq 0.1\text{s}$
115% tensión / <i>115% voltage</i>	$t_D= 296 \text{ ms} \geq 0.1\text{s}$	$t_D= 296 \text{ ms} \geq 0.1\text{s}$

MEDIDA DE LA INTENSIDAD LUMINOSA EFECTIVA / EFFECTIVE LUMINOUS INTENSITY MEASUREMENT

1. Intensidades luminosas efectivas medidas después de un minuto de encendido / *Effective luminous intensities measured after one minute of operation.*

Valor mínimo de J_e en el interior de los ángulos verticales especificados y de un ángulo horizontal de 360° alrededor del eje de referencia / *Minimum value of J_e within the specified vertical angle and horizontal angles of 360° around the reference axis*

- a) En el caso de la Categoría T un ángulo horizontal de 360° alrededor del eje de referencia / *In the case of Category T a horizontal angle of 360° around the reference axis*

	DÍA / DAY		NOCHE/ NIGHT		
	MUESTRA A / SAMPLE A	MUESTRA B / SAMPLE B	MUESTRA A / SAMPLE A	MUESTRA B / SAMPLE B	
0°	$J_e \geq 230$	---	$J_e \geq 100$	186.2	190.7
+8°	$J_e \geq 170$	---	$J_e \geq 70$	88.5	93.2
- 8°	$J_e \geq 170$	---	$J_e \geq 70$	140.9	126.8

Valor máximo de J_e / *Maximum value of J_e*

Muestra A / *Sample A*: **323.7**

Muestra B / *Sample B*: **327.1**

* LOS RESULTADOS PRESENTADOS SE REFIEREN UNICAMENTE A LA MUESTRA ENSAYADA.
THE PRESENTED RESULTS REFER ONLY TO THE TESTED SAMPLE

* QUEDA TERMINANTEMENTE PROHIBIDA LA REPRODUCCION PARCIAL DE ESTE INFORME SIN PERMISO EXPRESO DE IDIADA.
THE PARTIAL REPRODUCTION OF THIS REPORT WITHOUT THE PERMISSION OF IDIADA IS COMPLETELY FORBIDDEN

	MUESTRA A / SAMPLE A	MUESTRA B / SAMPLE B
En el interior $\pm 2^\circ$ / <i>Inside $\pm 2^\circ$</i> (de día / <i>by day</i> : $J_e \leq 1700$ / de noche / <i>by night</i> : $J_e \leq 700$)	CORRECTO / CORRECT	CORRECTO / CORRECT
En el interior $\pm 8^\circ$ / <i>Inside $\pm 8^\circ$</i> (de día / <i>by day</i> : $J_e \leq 1500$ / de noche / <i>by night</i> : $J_e \leq 600$)	CORRECTO / CORRECT	CORRECTO / CORRECT
En el exterior de las áreas anteriores / <i>Outside the above areas</i> (de día / <i>by day</i> : $J_e \leq 1000$ / de noche / <i>by night</i> : $J_e \leq 300$)	CORRECTO / CORRECT	CORRECTO / CORRECT

2. Intensidades luminosas medidas después que la intensidad de la luz de la luz especial de aviso haya alcanzado la estabilidad fotométrica (desviación inferior al $\pm 5\%$ en los últimos 15 minutos de funcionamiento / *Luminous intensities measured after the light output from the special warning lamp has reached photometric stability (deviation of less than ± 5 percent in the last 15 minutes of operation).*

Valor mínimo de J_e en el interior de los ángulos verticales especificados y de un ángulo horizontal de 360° alrededor del eje de referencia / *Minimum value of J_e within the specified vertical angle and horizontal angles of 360° around the reference axis*

- a) En el caso de la Categoría T un ángulo horizontal de 360° alrededor del eje de referencia / *In the case of Category T a horizontal angle of 360° around the reference axis*

	DÍA / DAY		NOCHE/ NIGHT			
		MUESTRA A / SAMPLE A	MUESTRA B / SAMPLE B		MUESTRA A / SAMPLE A	MUESTRA B / SAMPLE B
0°	$J_e \geq 230$	---	---	$J_e \geq 100$	169.3	173.4
$+8^\circ$	$J_e \geq 170$	---	---	$J_e \geq 70$	80.5	84.8
-8°	$J_e \geq 170$	---	---	$J_e \geq 70$	128.1	115.3

Valor máximo de J_e / *Maximum value of J_e*

Muestra A / *Sample A*: **294.3**

Muestra B / *Sample B*: **297.4**

	MUESTRA A / SAMPLE A	MUESTRA B / SAMPLE B
En el interior $\pm 2^\circ$ / <i>Inside $\pm 2^\circ$</i> (de día / <i>by day</i> : $J_e \leq 1700$ / de noche / <i>by night</i> : $J_e \leq 700$)	CORRECTO / CORRECT	CORRECTO / CORRECT
En el interior $\pm 8^\circ$ / <i>Inside $\pm 8^\circ$</i> (de día / <i>by day</i> : $J_e \leq 1500$ / de noche / <i>by night</i> : $J_e \leq 600$)	CORRECTO / CORRECT	CORRECTO / CORRECT
En el exterior de las áreas anteriores / <i>Outside the above areas</i> (de día / <i>by day</i> : $J_e \leq 1000$ / de noche / <i>by night</i> : $J_e \leq 300$)	CORRECTO / CORRECT	CORRECTO / CORRECT

* LOS RESULTADOS PRESENTADOS SE REFIEREN UNICAMENTE A LA MUESTRA ENSAYADA.

THE PRESENTED RESULTS REFER ONLY TO THE TESTED SAMPLE

* QUEDA TERMINANTEMENTE PROHIBIDA LA REPRODUCCION PARCIAL DE ESTE INFORME SIN PERMISO EXPRESO DE IDIADA.

THE PARTIAL REPRODUCTION OF THIS REPORT WITHOUT THE PERMISSION OF IDIADA IS COMPLETELY FORBIDDEN

Si dos o más sistemas ópticos están integrados en una luz especial de aviso / *If the optical systems are integrated in one special warning lamp :*

<p>Cada sistema óptico es conforme con las prescripciones fotométricas en el interior del ángulo horizontal que no está cubierto por uno de los otros sistemas ópticos. / <i>Each optical system fulfils the photometric requirements within the horizontal angle which is not covered by one of the other optical systems (8.1. Annex 5)</i></p>	<p>CORRECTO / CORRECT</p>
<p>Todos los sistemas ópticos funcionan en fase. Nota: Sólo se aplica a cada mitad de la barra completa. / <i>All the optical systems work in phase.</i> <i>Note: this applies only to each half of a complete bar. (8.2. Annex 5)</i></p>	<p>CORRECTO / CORRECT</p>
<p>Una luz especial de aviso que está compuesta de más de una unidad separada, se acepta la(s) disposición(es) geométrica instalada en el vehículo, si la distribución parcial de la luz de cada unidad simple separada se superpone con la distribución de luz parcial adyacente en el interior del campo angular horizontal de 360° y el campo angular vertical especificado para la categoría pertinente en una posición geométrica correspondiente a la distancia de 20 m, desde el vehículo en un plano vertical perpendicular al eje longitudinal del vehículo y localizado en la posición media entre las unidades de luces en un lado del vehículo / <i>Special warning lamps device which is comprised of more than one separate unit, the geometrical arrangement(s) as installed at the vehicle is acceptable, if the partial light distribution of each single separate unit is overlapping with each adjacent partial light distribution inside a horizontal angular range of 360° and in a vertical angular range as specified for the relevant category in a geometrical position corresponding to a distance of 20 m, from the vehicle on a vertical plane that is perpendicular to the longitudinal axis of the vehicle and located midway between the lamp units on a side of the vehicle. (7.2.1 Annex 5)</i></p>	<p>NO APLICABLE / NOT APPLICABLE</p>
<p>El vehículo dispone de un dispositivo capaz de detectar el fallo de una parte del sistema de la luz especial de aviso o la detección de fallo se realiza mediante un dispositivo previsto por el fabricante de la luz especial de aviso / <i>Detection of the failure of a part of special warning system on the car or detection by the special warning lamp manufacturer (8.3 Annex 5)</i></p>	<p>CORRECTO / CORRECT</p>

Lugar del ensayo / *Test place:* L'Albornar, E-43710 Santa Oliva (Tarragona)

Fecha del ensayo / *Test date:* 20/09/2016



Joan Fonts Sala
INGENIERO DE ENSAYOS
TEST ENGINEER

* LOS RESULTADOS PRESENTADOS SE REFIEREN UNICAMENTE A LA MUESTRA ENSAYADA.
THE PRESENTED RESULTS REFER ONLY TO THE TESTED SAMPLE

* QUEDA TERMINANTEMENTE PROHIBIDA LA REPRODUCCION PARCIAL DE ESTE INFORME SIN PERMISO EXPRESO DE IDIADA.
THE PARTIAL REPRODUCTION OF THIS REPORT WITHOUT THE PERMISSION OF IDIADA IS COMPLETELY FORBIDDEN

DOCUMENTACIÓN TÉCNICA /
TECHNICAL DOCUMENTATION

First application date	2016-7-28		<input type="checkbox"/>
First extension date	<input type="checkbox"/>		
1. Specification data	<input type="checkbox"/>		
Type	WA-027C2A-MZ-N		
Variants	WA-027C2A-MZ-N : (1≤N≤12) WA-027C2A-MZ-1, WA-027C2A-MZ-2, WA-027C2A-MZ-3, WA-027C2A-MZ-4, WA-027C2A-MZ-5, WA-027C2A-MZ-6, WA-027C2A-MZ-7, WA-027C2A-MZ-8, WA-027C2A-MZ-9, WA-027C2A-MZ-10, WA-027C2A-MZ-11, WA-027C2A-MZ-12		
Function	Warning Lamp		
Colour	Amber		
Rated	Voltage	12/24V	
	Wattage	48W	
Applicable Regulation (ECE)	R65		
Location of marking	Number and category of light source	LED*56	
Trade mark			
	Marked on the Cover		

2. Construction and material

Construction	Material	Remarks
Cover	PC	black
Inner Lens	PC	Clear
Electrical wiring	<input type="checkbox"/>	<input type="checkbox"/>

3、Name and address of Applicant and Address	Guangzhou Forda Signal Equipment Co., Ltd.
	Building C West side of Dongfeng Highway Auto City Huadu District ,Guangzhou,China
4. Name and address of manufacturer :	Guangzhou Forda Signal Equipment Co., Ltd.
	Building C West side of Dongfeng Highway Auto City Huadu District ,Guangzhou,China

Note : Approval markings are shown in the attached drawing.

This information document consists of 14 pages.

PC16090293

IDIADA

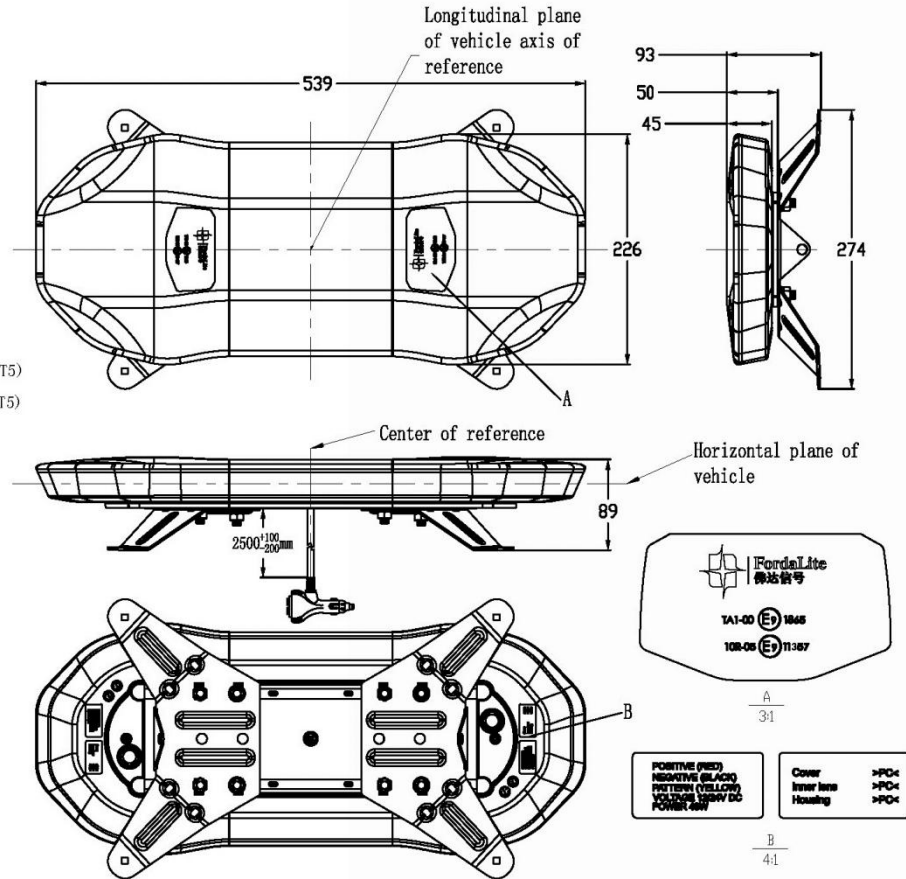
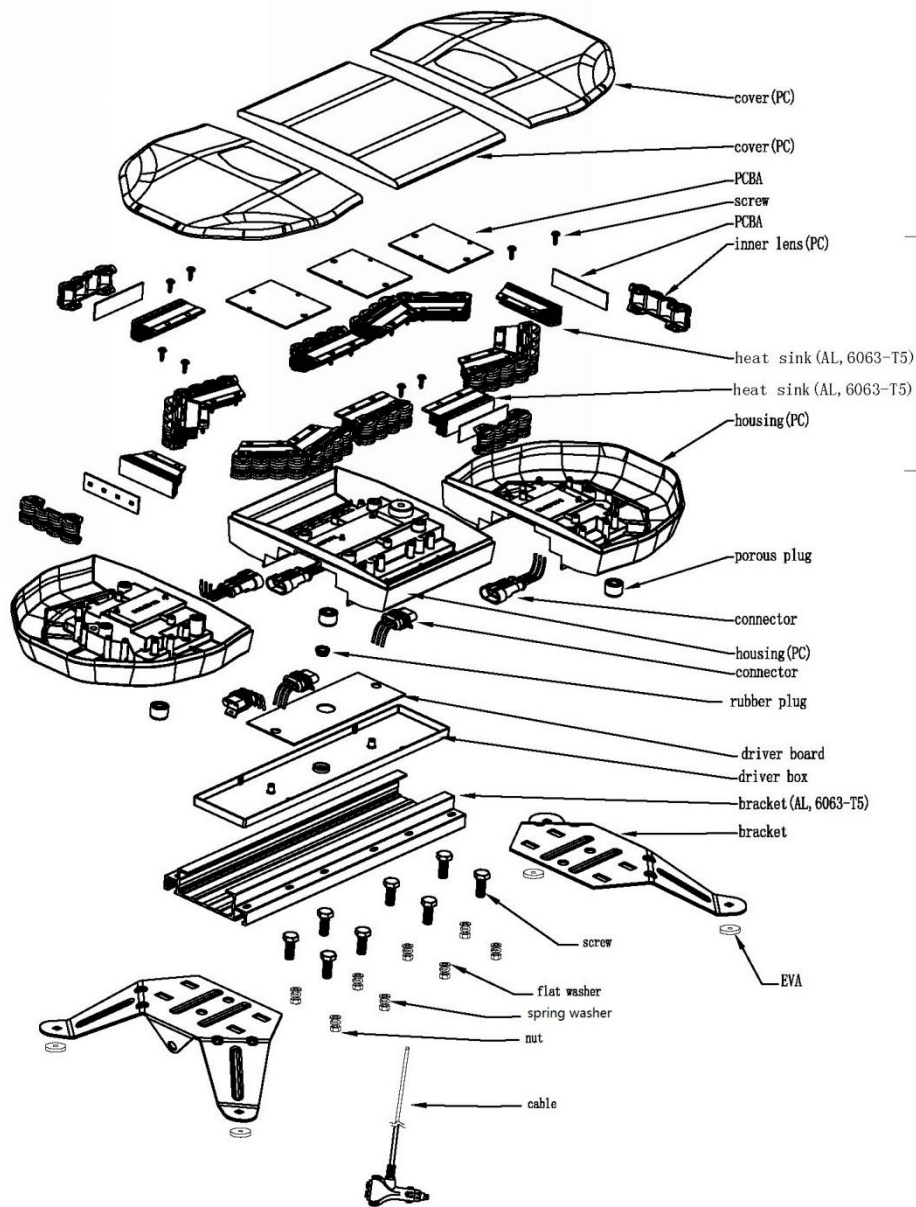

Specification:

1. Functions: LED warning lamp;
2. Input Voltage: 12V/24V.

FordaLite
 佛达信号
 WA-027C2A-MZ-1

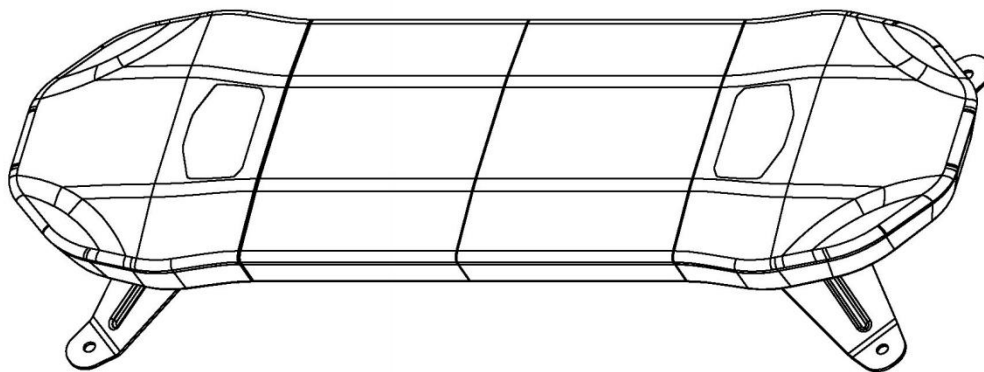
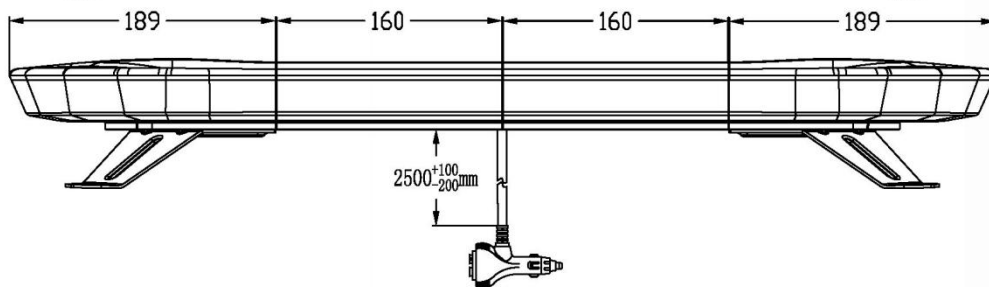
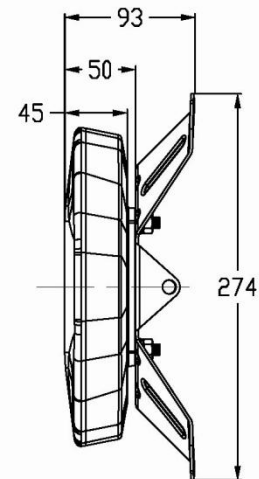
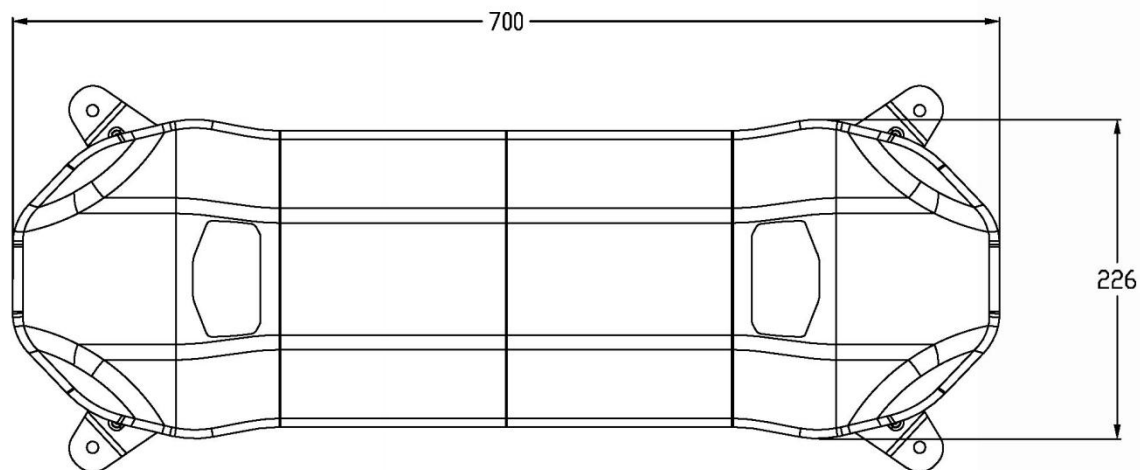

Specification:

1. Functions: LED warning lamp;
2. Input Voltage: 12V/24V.



WA-027C2A-MZ-2

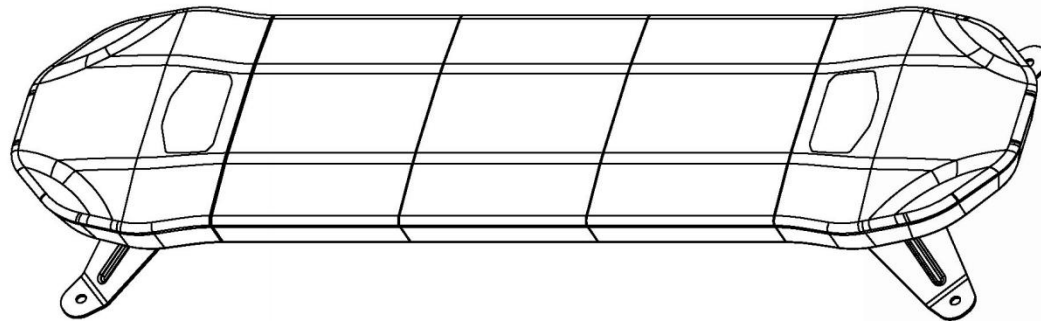
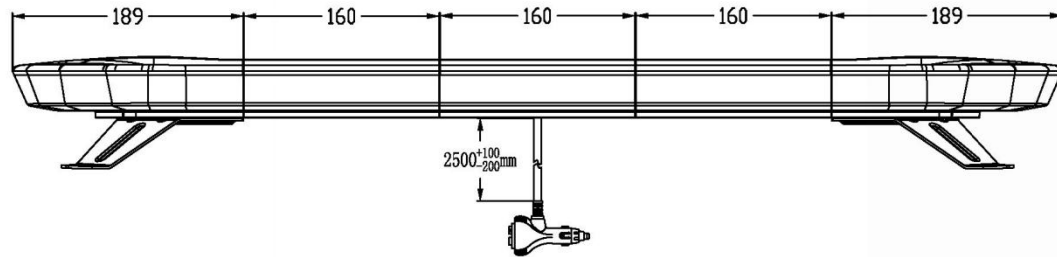
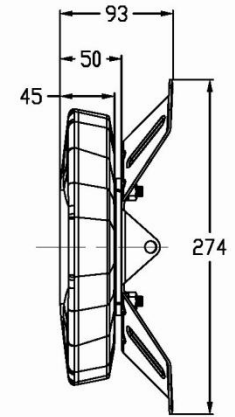
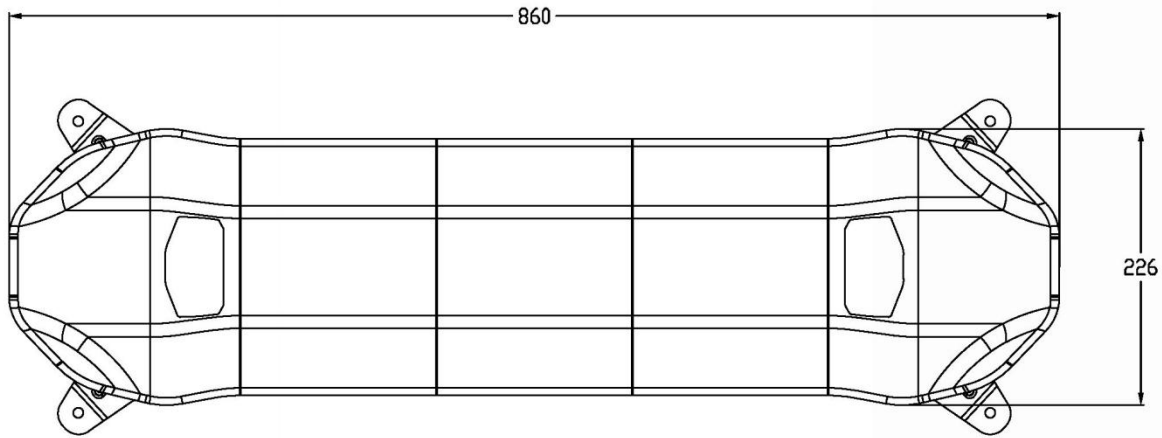

- Specification:
1. Functions: LED warning lamp;
 2. Input Voltage: 12V/24V.



WA-027C2A-MZ-3

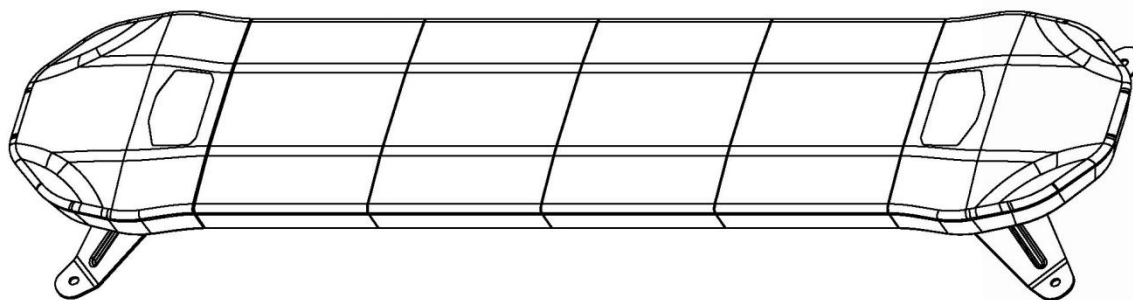
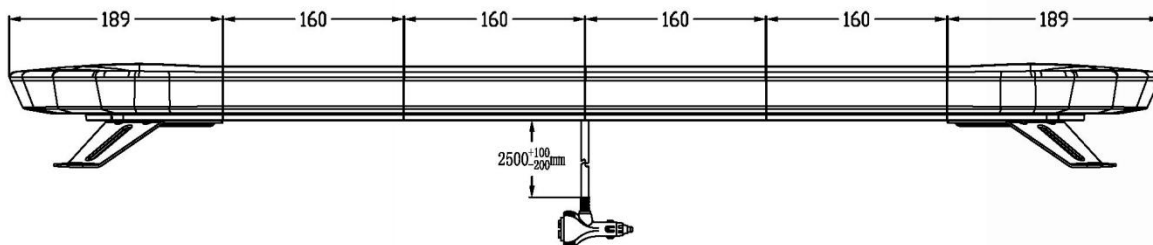
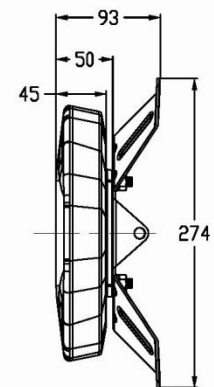
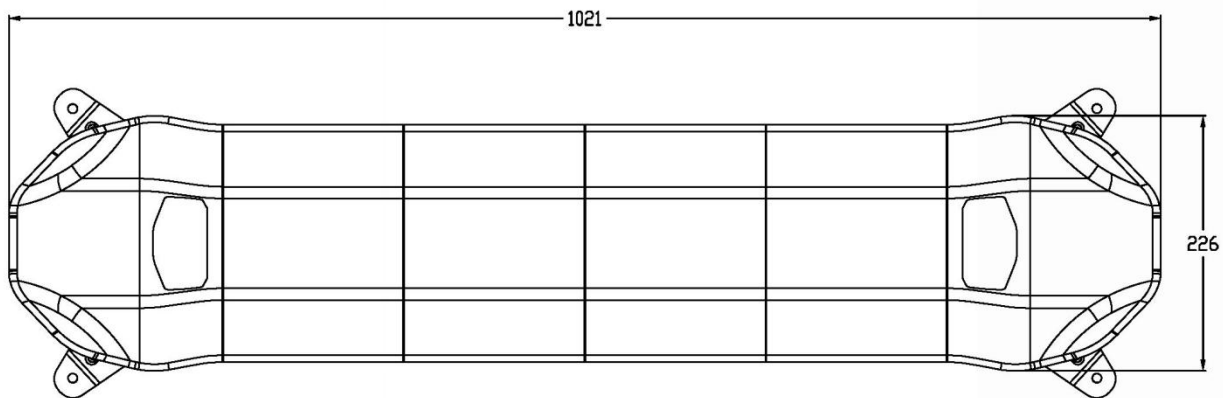

- Specification:
1. Functions: LED warning lamp;
 2. Input Voltage: 12V/24V.



WA-027C2A-MZ-4

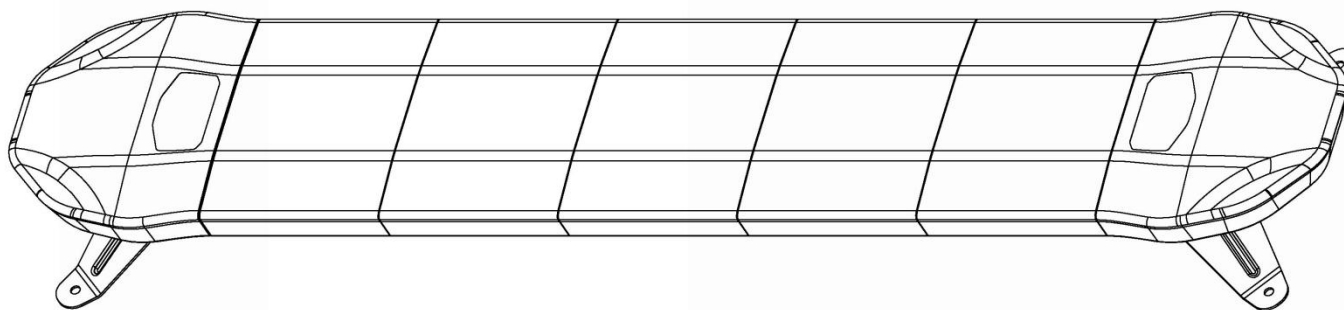
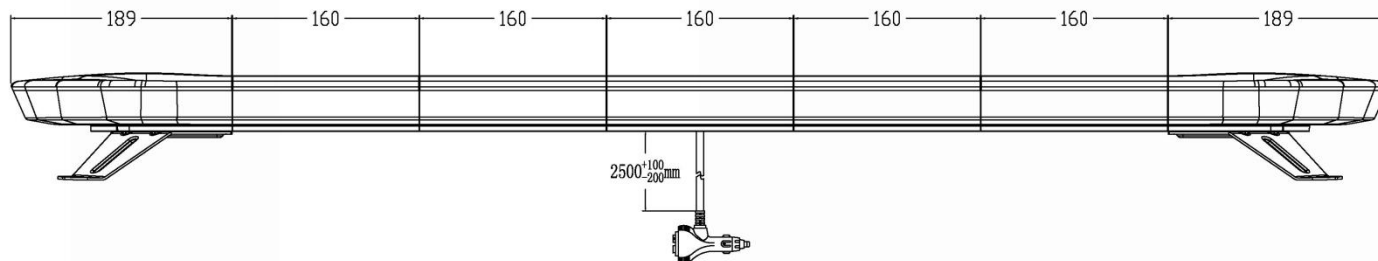
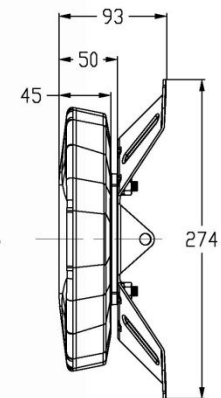
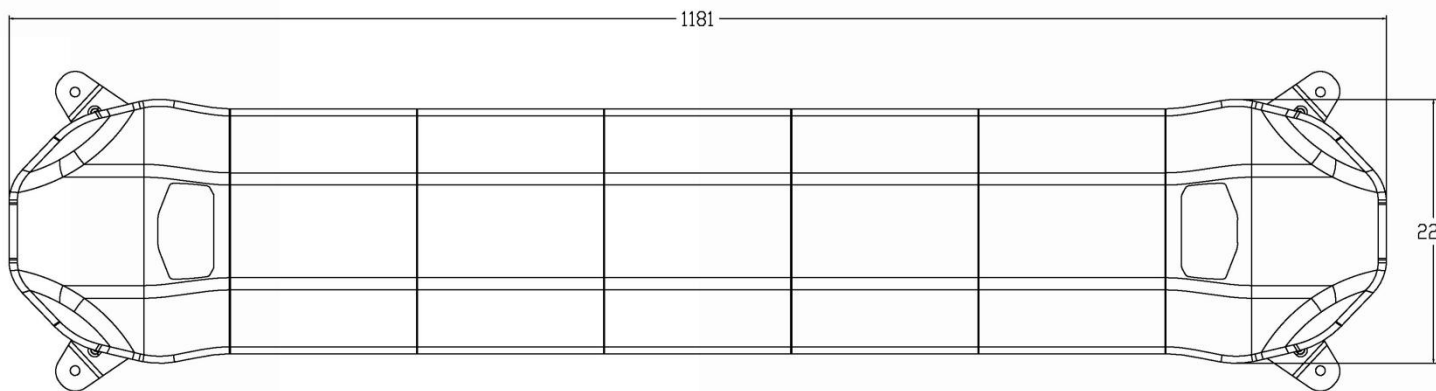

Specification:
 1. Functions: LED warning lamp;
 2. Input Voltage: 12V/24V.



WA-027C2A-MZ-5

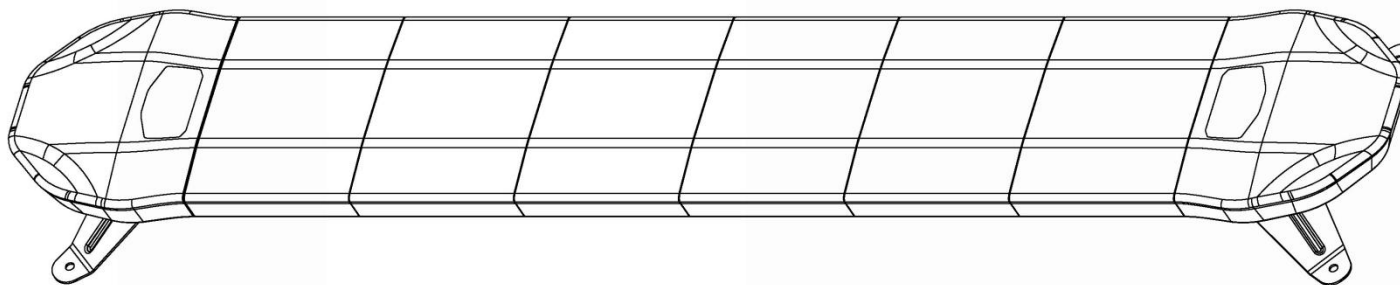
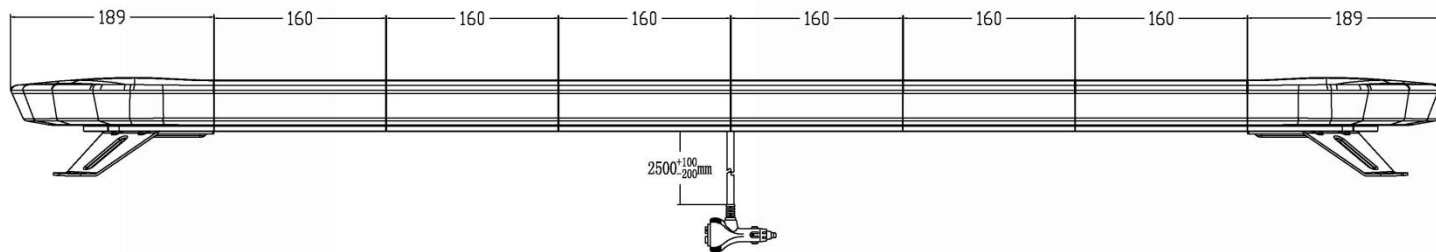
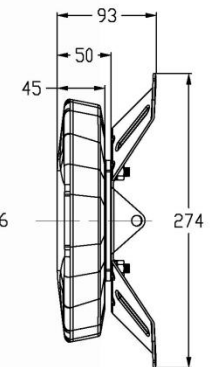
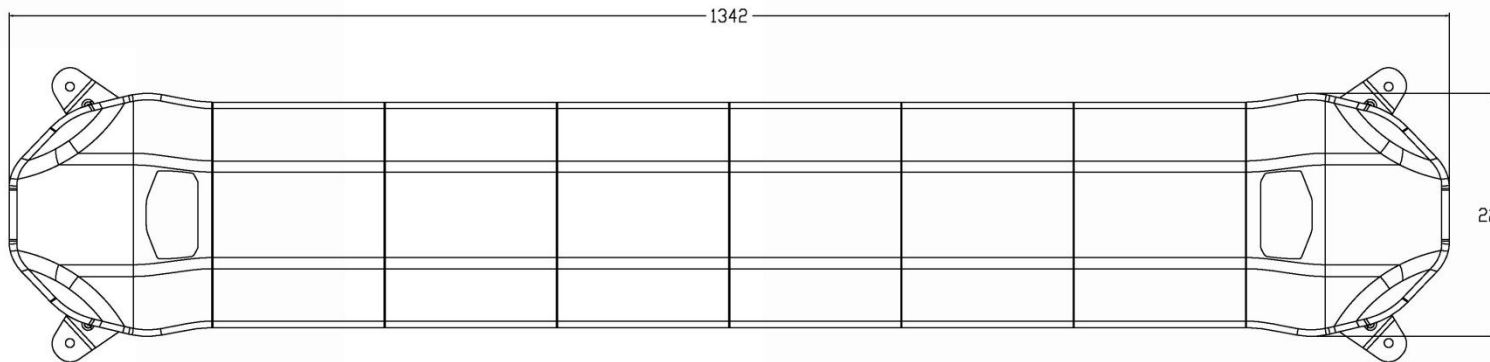

Specification:
 1. Functions: LED warning lamp;
 2. Input Voltage: 12V/24V.



WA-027C2A-MZ-6

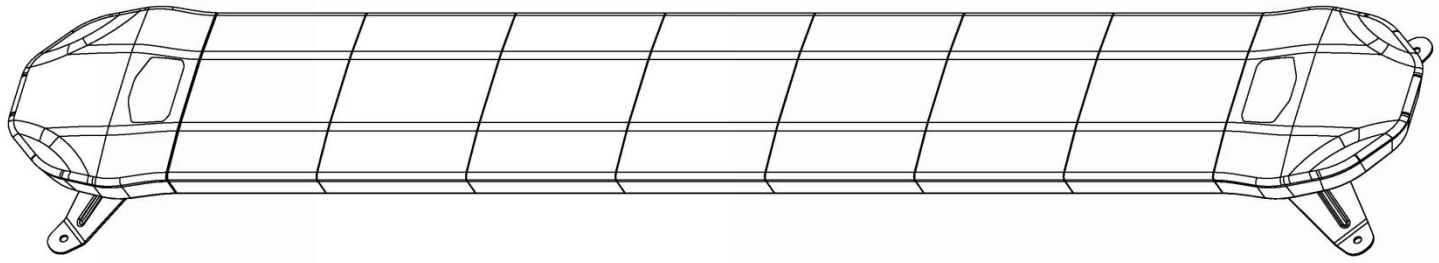
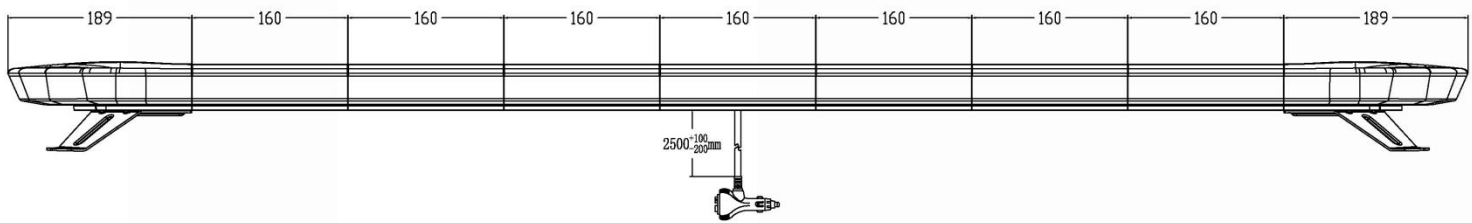
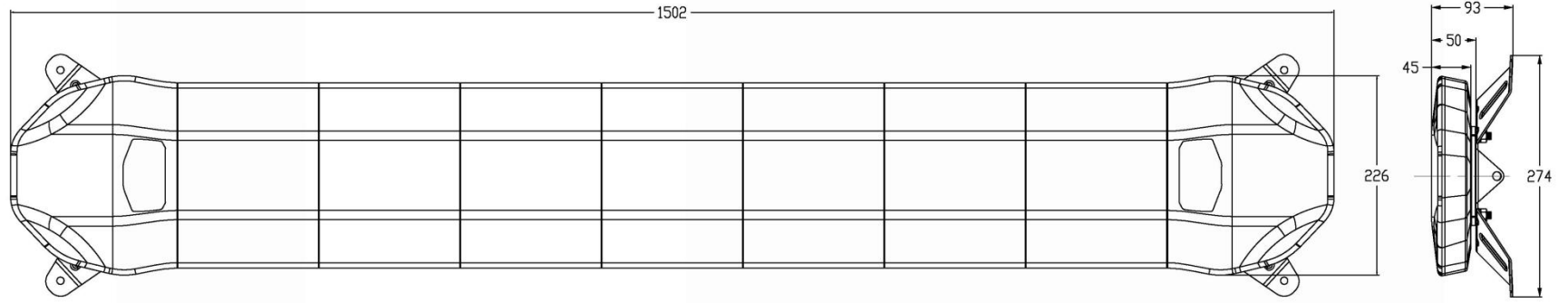

Specification:
 1. Functions: LED warning lamp;
 2. Input Voltage: 12V/24V.

	Fordalite 佛达信号
WA-027C2A-MZ-7	

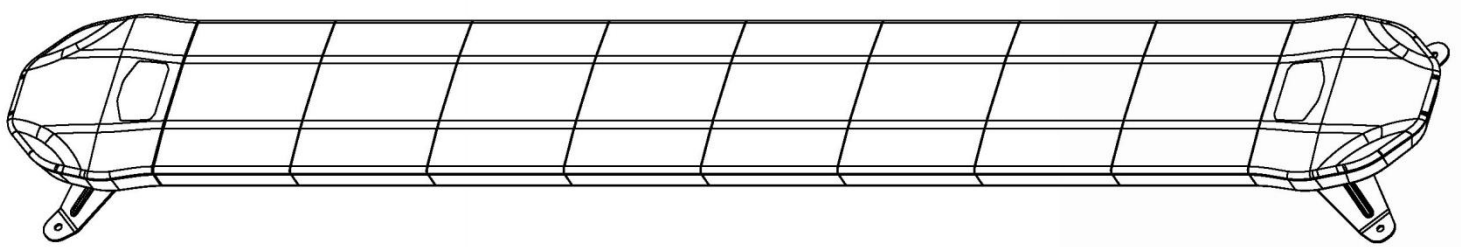
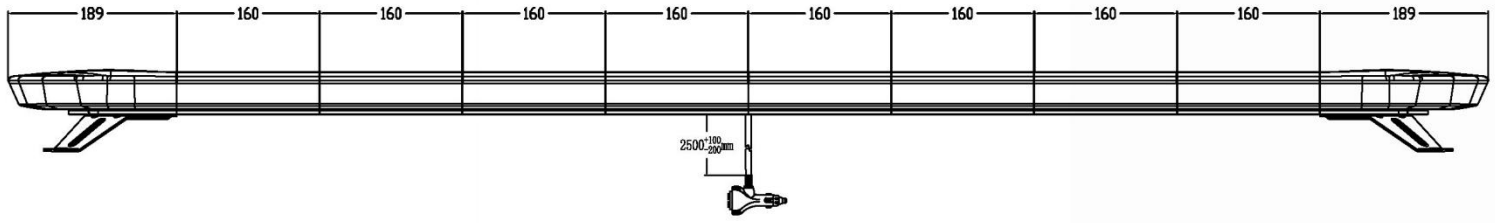
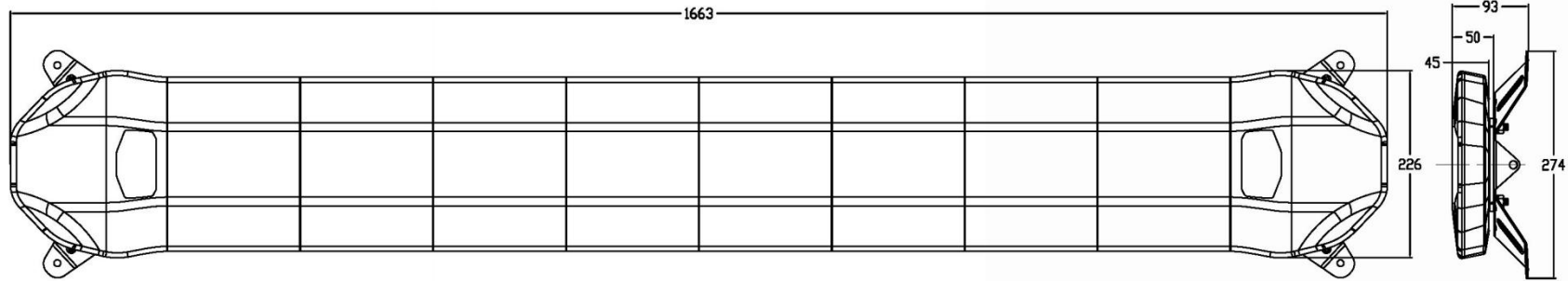

Specification:
 1. Functions: LED warning lamp;
 2. Input Voltage: 12V/24V.

	Fordalite 佛达信号
WA-027C2A-MZ-8	

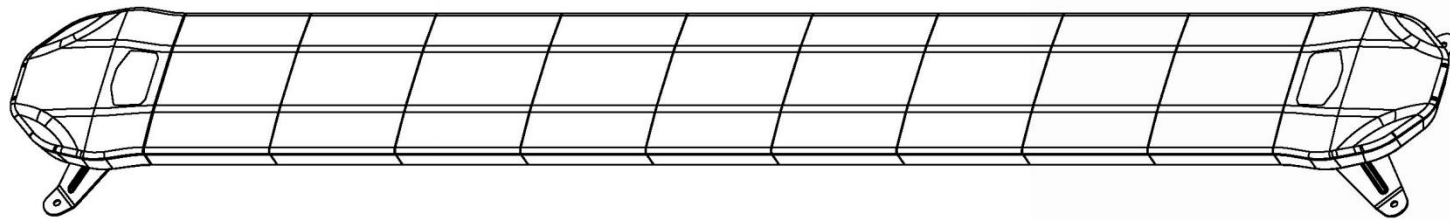
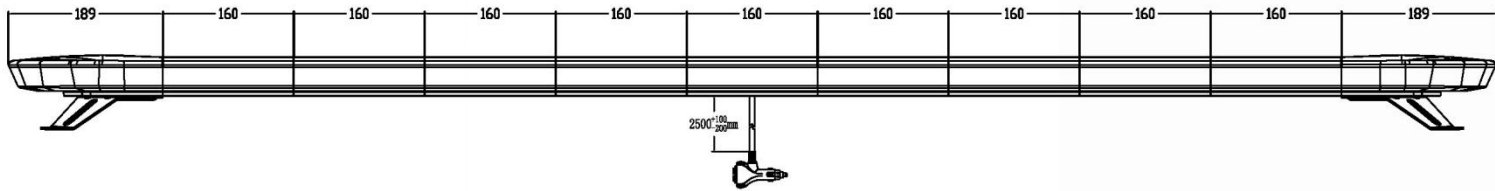
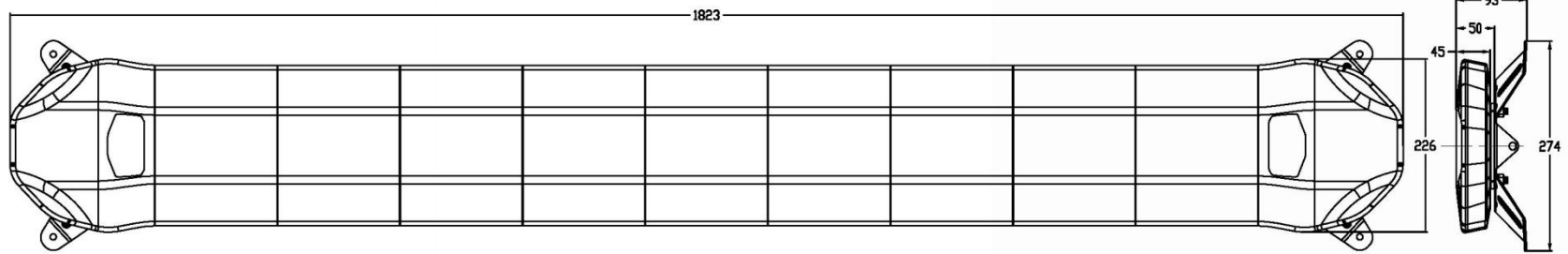

Specification:
 1. Functions: LED warning lamp;
 2. Input Voltage: 12V/24V.

	Fordal Lite 佛达信号
WA-027C2A-MZ-9	

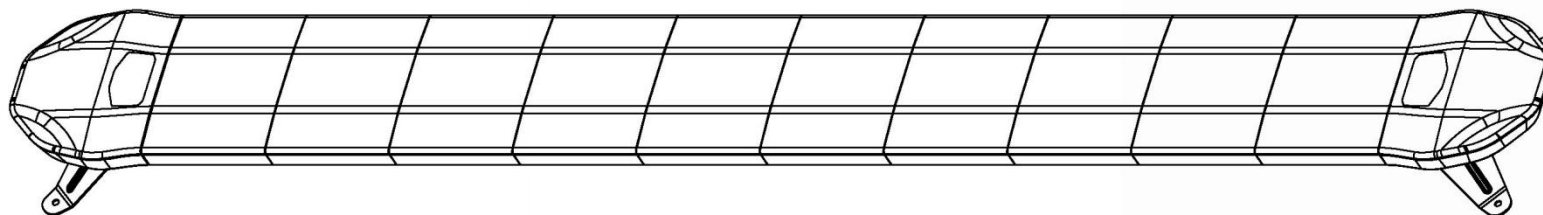
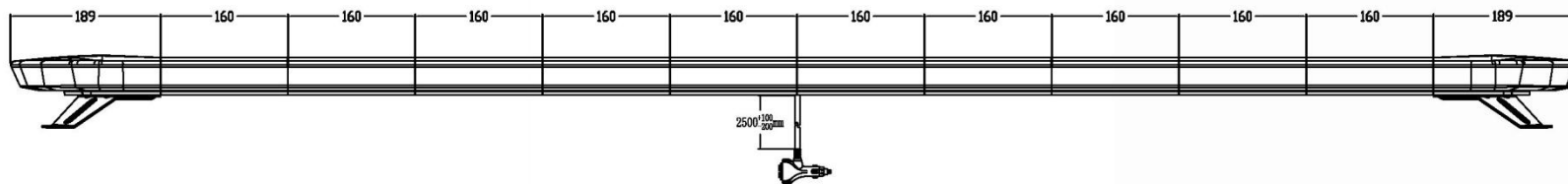
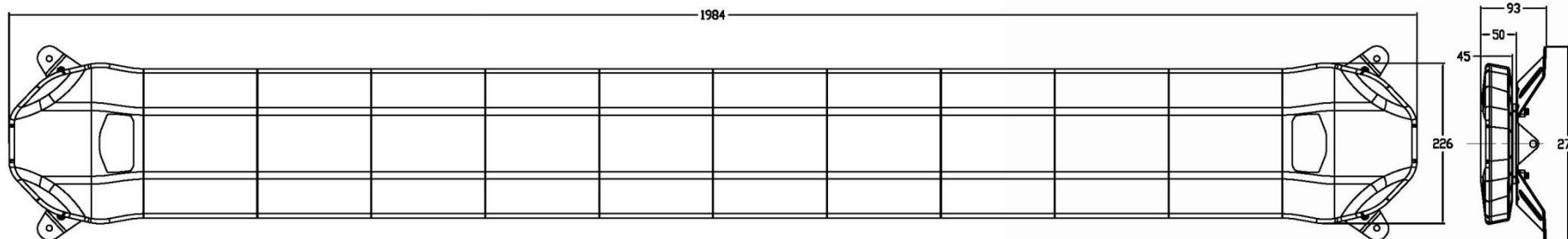

Specification:
 1. Functions: LED warning lamp;
 2. Input Voltage: 12V/24V.



WA-027C2A-MZ-10

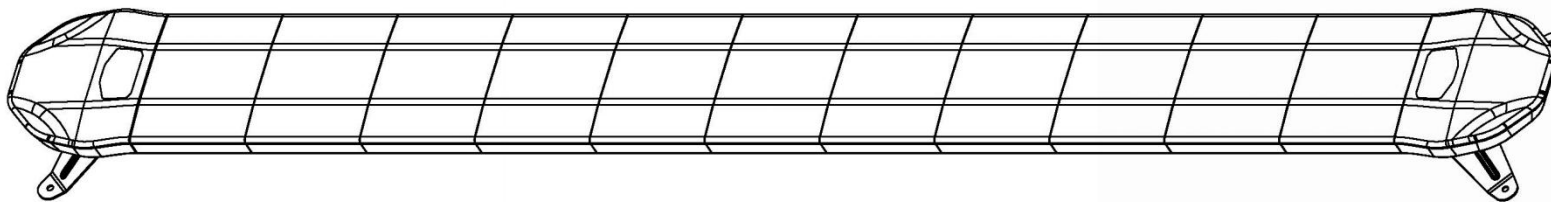
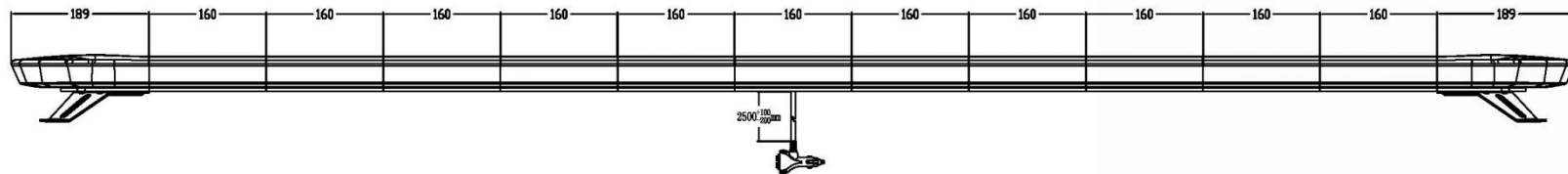
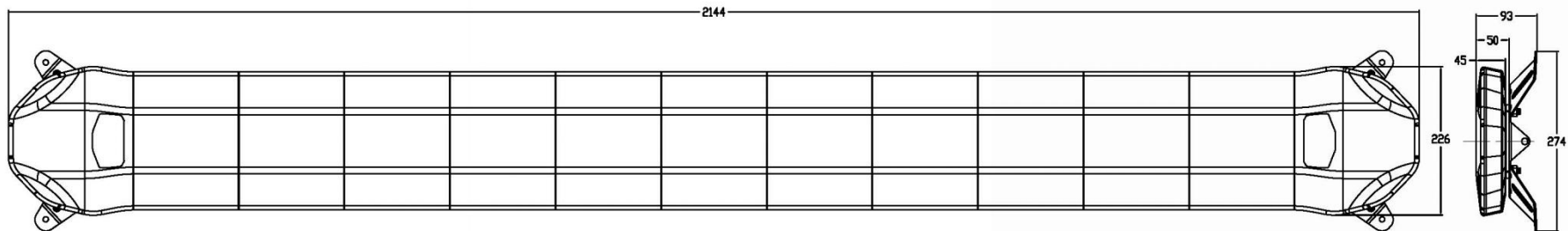

Specification:
 1. Functions: LED warning lamp;
 2. Input Voltage: 12V/24V.

 Fondalite 佛达信号
WA-027C2A-MZ-11

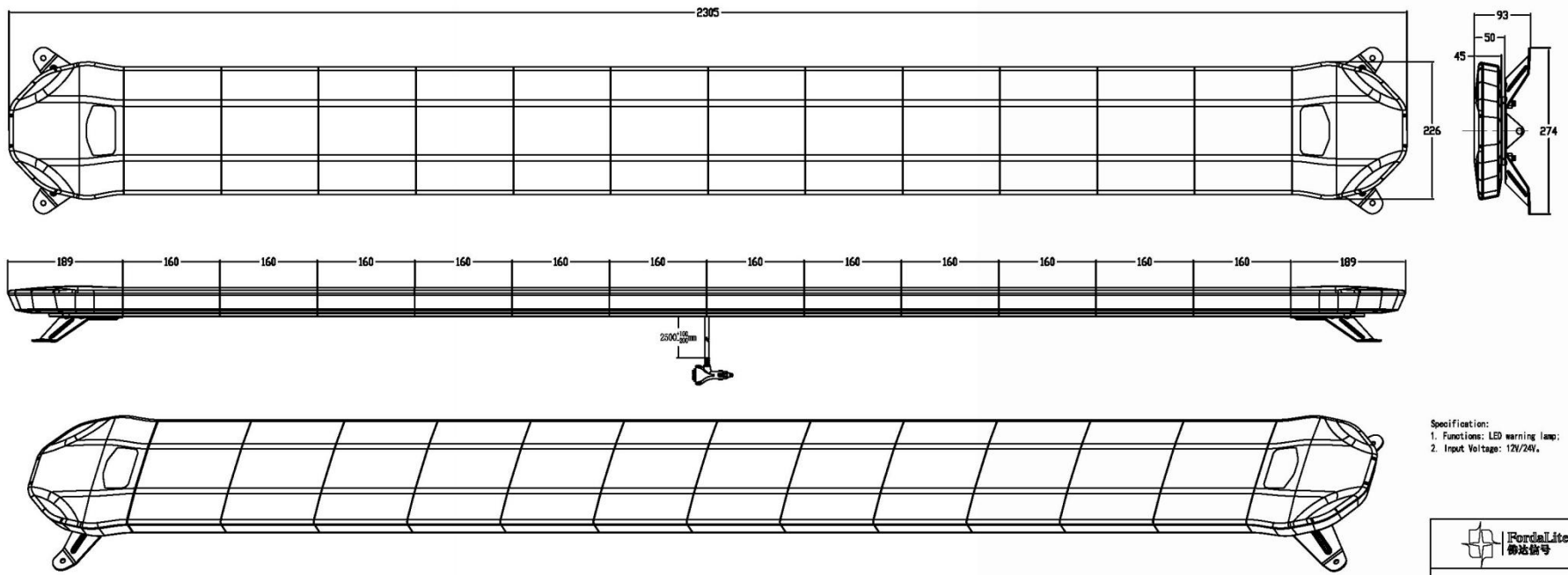

Specification:
 1. Functions: LED warning lamp;
 2. Input Voltage: 12V/24V.

 Fordialite 弗达达号
WA-027C2A-MZ-12

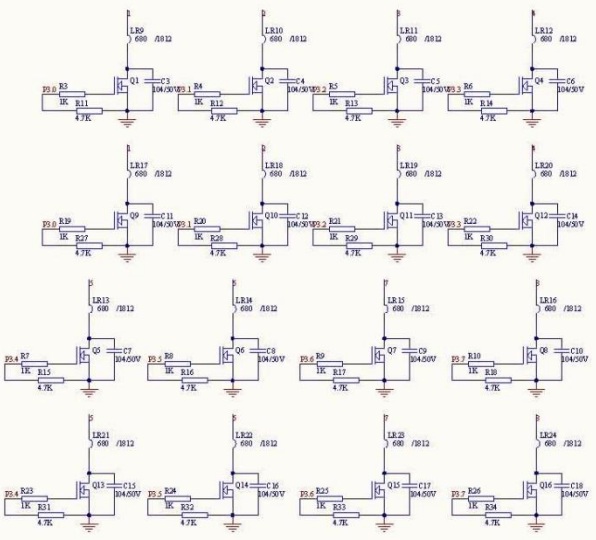
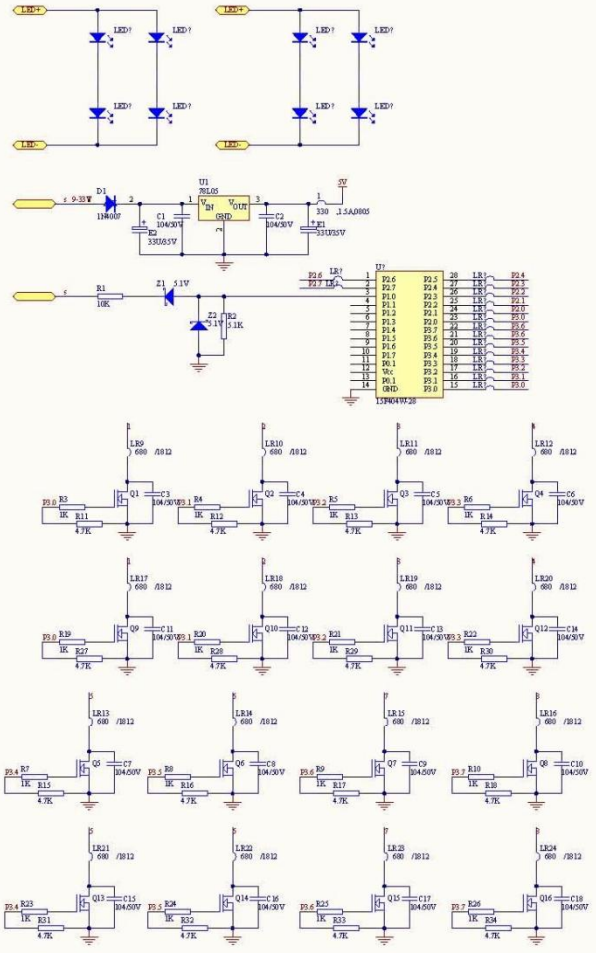
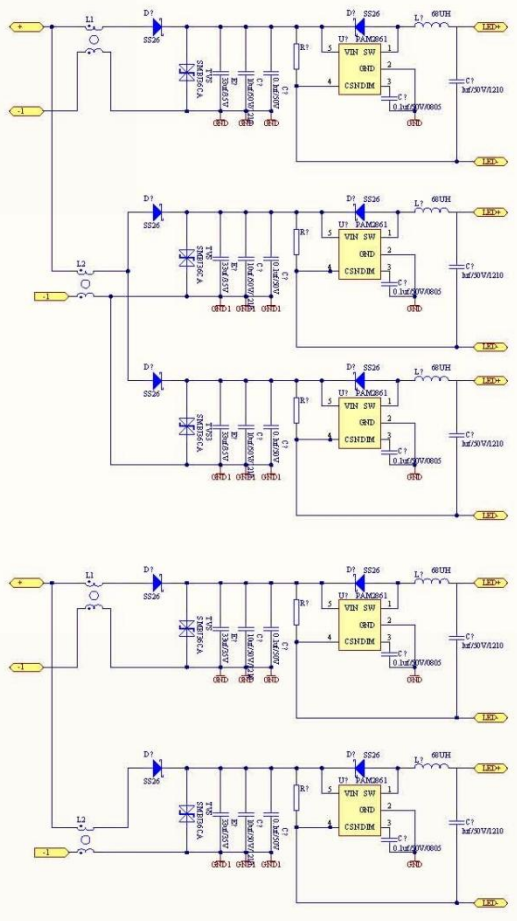

WA-027C2A-MZ-N