



## INSTALLATION INSTRUCTIONS FOR PART 99-6510

### APPLICATIONS

See application list inside

# Chrysler/Dodge/Jeep 2005-2008 99-6510

### KIT FEATURES

- DIN radio provision with pocket
- ISO DIN radio provision with pocket
- Double DIN radio provision
- Stacked ISO unit provision
- *Designed for vehicles with factory navigation radios*

### KIT COMPONENTS

- A) Radio housing • B) ISO brackets • C) ISO trim plate • D) Double DIN brackets • E) Pocket
- F) Double DIN trim plate

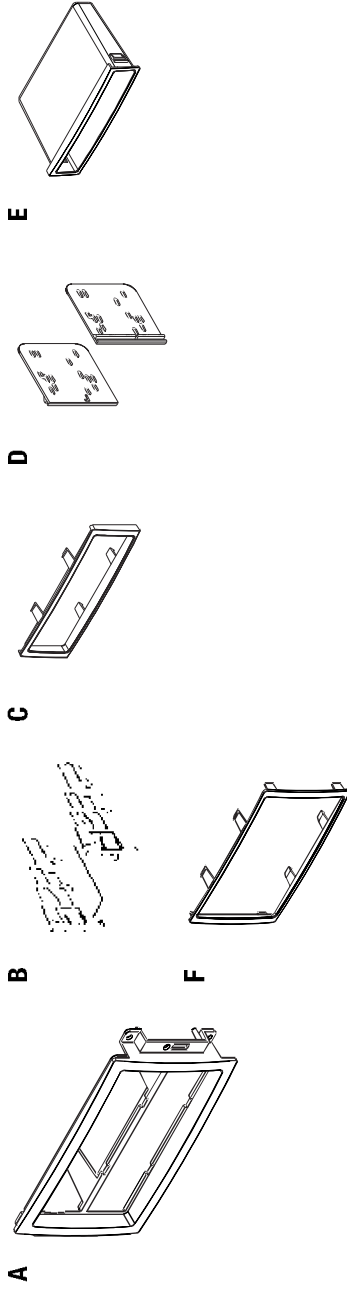

### WIRING & ANTENNA CONNECTIONS (sold separately)

Wiring Harness:

- XSVI-6502-NAV - Chrysler CAN R.A.P. interface 2004-up
  - CHTO-01 - Chrysler CAN amp interface 2004-up
- Antenna Adapter:
- 40-CR10 - Chrysler antenna adapter 2004-up

### TOOLS REQUIRED

- Flat blade screwdriver • Panel Removal Tool
- Phillips Screwdriver • Socket Wrench • Cutting tool

**CAUTION:** Metra recommends disconnecting the negative battery terminal before beginning any installation. All accessories, switches, and especially air bag indicator lights must be plugged in before reconnecting the battery or cycling the ignition.

**NOTE:** Refer to the instructions included with the aftermarket radio.

REV. 9/18/2013 INST99-6510

**METRA. The World's best kits.<sup>TM</sup>**

**1-800-221-0932**

**metraonline.com**

© COPYRIGHT 2004-2011 METRA ELECTRONICS CORPORATION



99-6510

## Applications

<b>Chrysler</b>			
300.....	2005-2007		– Jeep Commander 2007 ..... 7
Aspen.....	2007		– Jeep Compass 2007-2008 ..... 7
			– Jeep Grand Cherokee 2005-2007 ..... 6
<b>Dodge</b>			– Jeep Patriot 2007-2008..... 7
Caliber.....	2007-2008		
Charger.....	2005-2007		<b>Kit Assembly</b>
Durango.....	2005-2007		– DIN radio provision with pocket ..... 8
Magnum.....	2005-2007		– ISO radio provision with pocket..... 8
Ram 1500 (without center console)/	2006-2008		– Double DIN radio provision..... 9
2500/3500.....	2006-2008		– Stacked ISO unit provision ..... 9
Ram 1500 (mini center console)/	2006-2008		
2500/3500.....	2006-2008		
Ram 1500 (full center console)/	2006-2008		
2500/3500.....	2006-2008		

## Jeep

Commander.....	2007
Compass.....	2007-2008
Grand Cherokee.....	2005-2007
Patriot.....	2007-2008

**Designed for vehicles with factory navigation radios**

**Using this kit in vehicles without factory navigation requires the purchase of a factory navigation radio trim panel from your local Chrysler, Dodge or Jeep parts department.**



## Chrysler Aspen 2007 Dodge Durango 2005-2007

1. Remove (2) 7 mm screws from the inside of the pocket facing upward. (Figure A)
2. Unclip and remove the entire trim panel surrounding the radio and climate controls. (Figure B)
3. Remove (4) 7 mm screws securing radio to dash and remove radio. (Figure C)

*Continue to kit assembly*

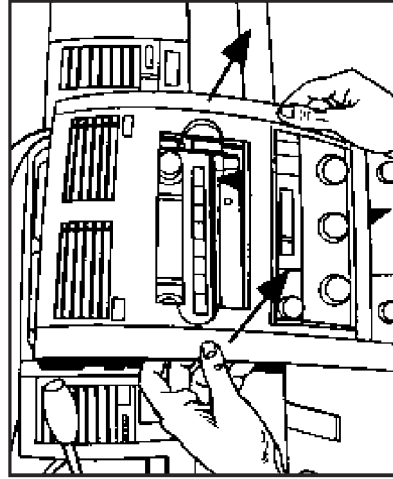

(Figure B)

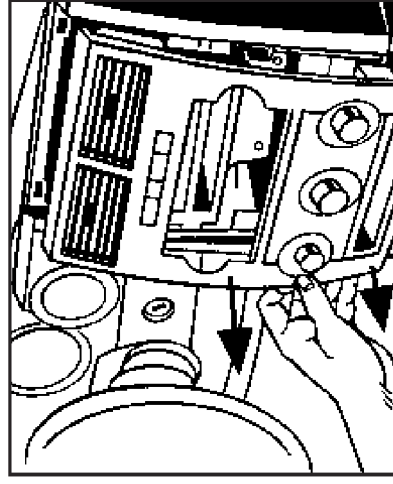

(Figure A)

1. Unclip and remove entire panel surrounding radio and climate controls, including A/C vents. (Figure A)
2. Remove (4) 7 mm screws securing radio to dash and remove radio. (Figure B)

*Continue to kit assembly*

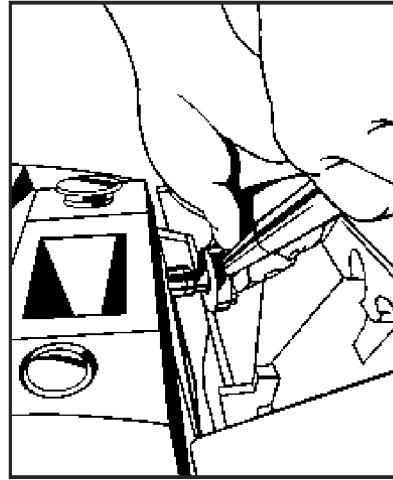

(Figure A)

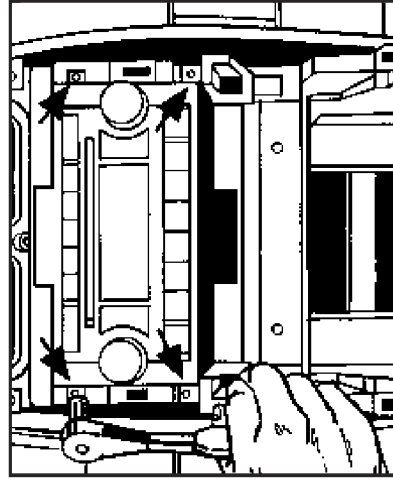

(Figure C)

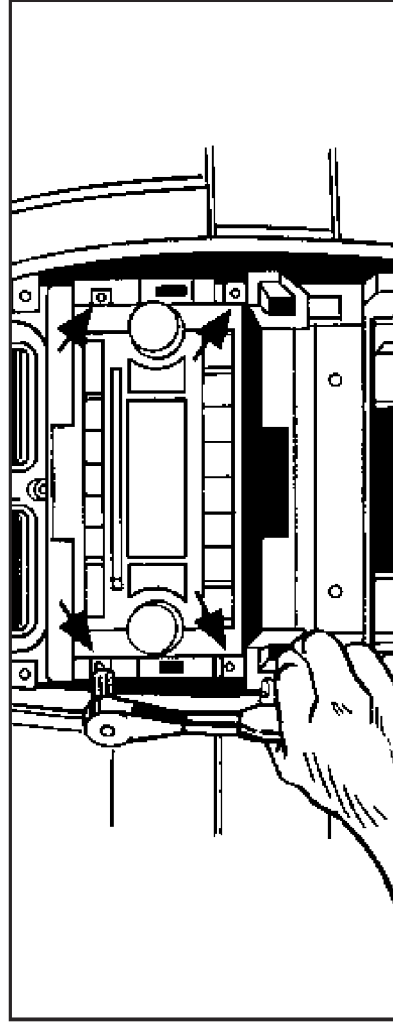

(Figure B)



## Chrysler 300 2005-2007

1. Unclip and remove entire panel surrounding radio and climate controls, including A/C vents and clock. (Figure A)
2. Remove (4) 7 mm screws securing radio to dash and remove radio. (Figure B)

*Continue to kit assembly*

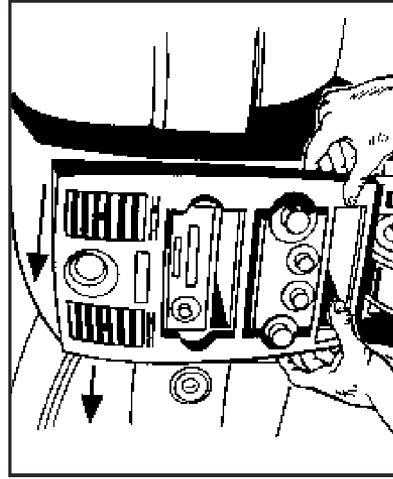

(Figure A)

## Dodge Ram 1500 (without center console)/ Ram 2500/3500 2006-2008

1. Open cup holder and remove (2) Phillips screws facing up on front edge of radio/climate control panel. (Figure A)
2. Unclip and remove entire panel surrounding radio and climate controls, including A/C vents. (Figure B)
3. Remove (4) 7 mm screws securing radio to dash and remove radio.

*Continue to kit assembly*

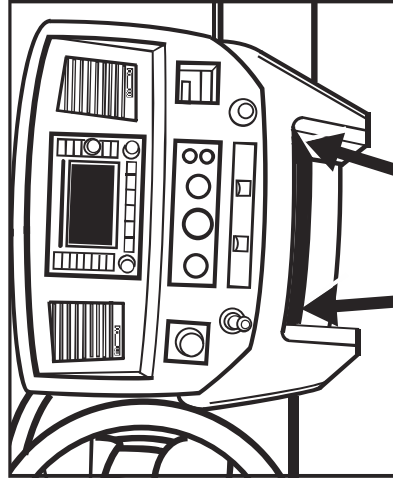

(Figure A)

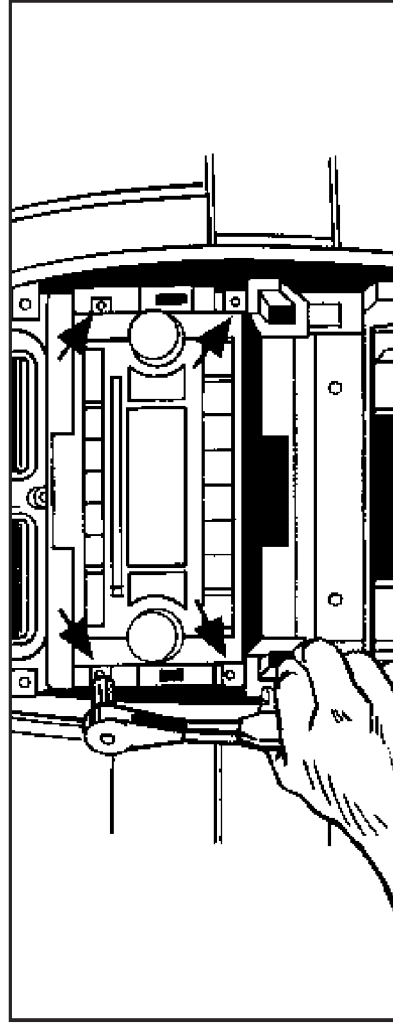

(Figure B)

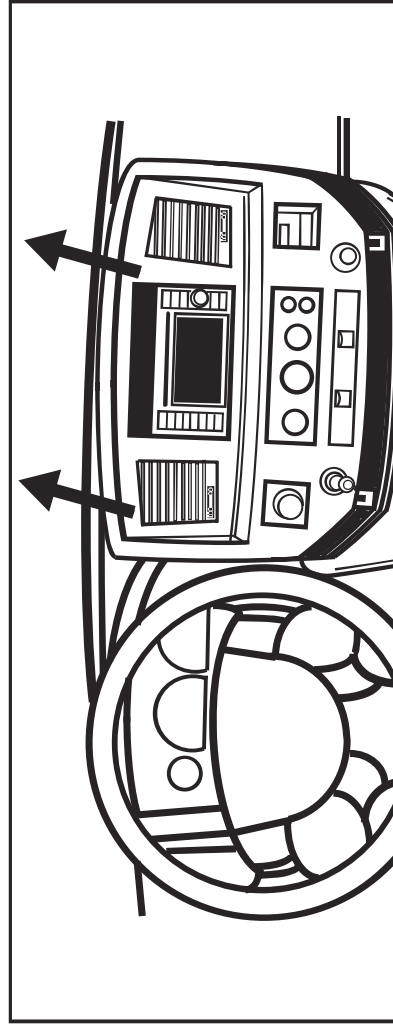

(Figure B)



## Dash Disassembly 99-6510

### Dodge Ram 1500 (with mini center console)/ Ram 2500/3500 2006-2008

1. If vehicle has floor shifter, remove shifter knob.
2. Remove center console inserts, if present. (Figure A)
3. Remove screws securing the rear center console to the floor panel. Lift up on the rear center console to clear the gearshift lever, if present. (Figure B)
4. Remove screws securing the front center console to the floor panel. Unclip and remove the front center console. (Figure C)

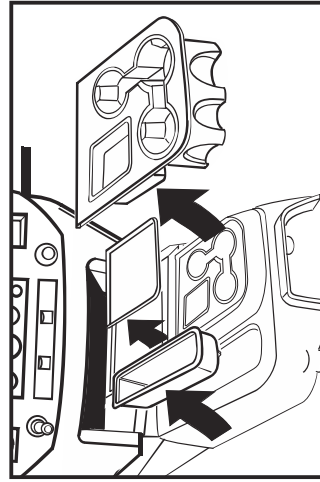

(Figure A)

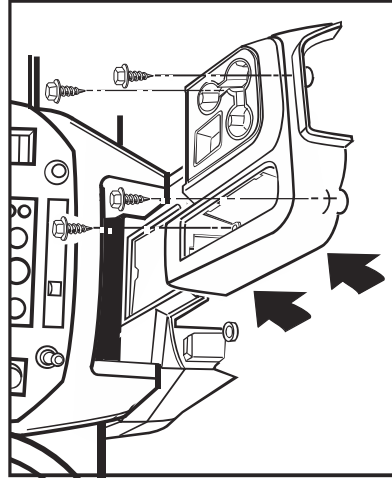

(Figure B)

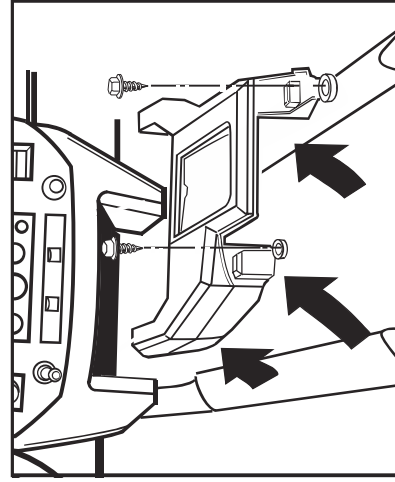

(Figure C)

5. Loosen two 8 mm screws at bottom of dash. Unsnap lower panel.
6. Remove (2) Phillips screws facing up on front edge of radio/climate control panel. (Figure D)
7. Unclip and remove entire panel surrounding radio and climate controls, including A/C vents. (Figure E)

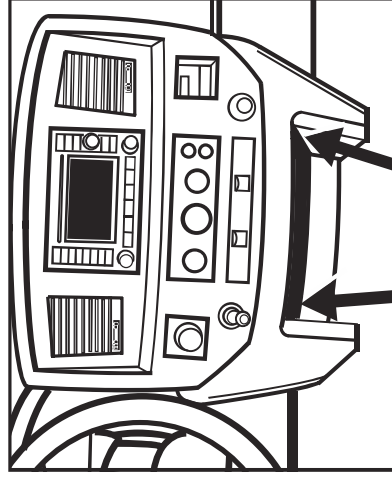

(Figure D)

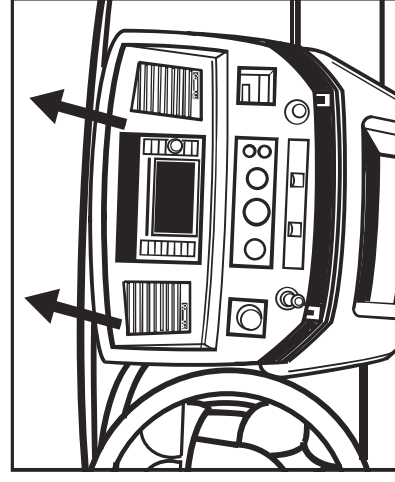

(Figure E)

8. Remove (4) 7 mm screws securing radio to dash and remove radio.

*Continue to kit assembly*



## Dash Disassembly 99-6510

### Dodge Ram 1500 (with full center console)/ Ram 2500/3500 2006-2008

1. If vehicle has floor shifter, remove shifter knob.
2. Unsnap and remove console front top cover (closest to the dash). (Figure A)
3. Remove two 8 mm screws from under console cover (previously removed). Remove front section of console. (Figure B)
4. Loosen two 8 mm screws at bottom of dash. Unsnap lower panel.

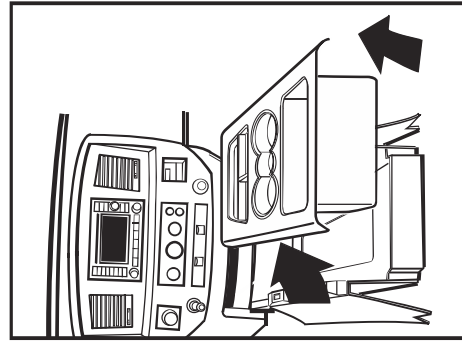

(Figure A)



(Figure B)

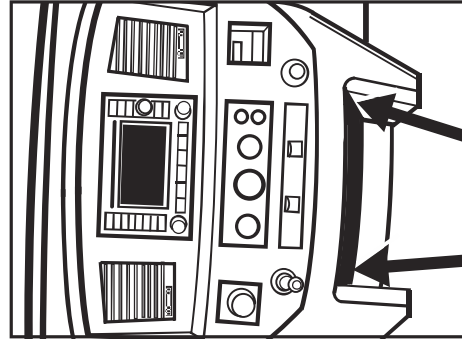

(Figure C)

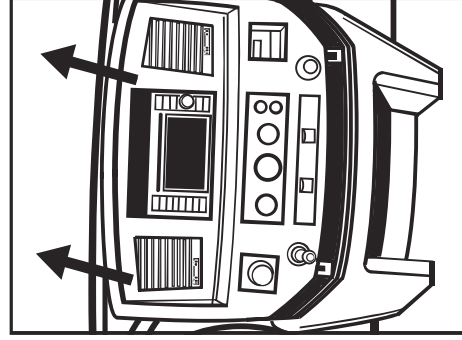

(Figure D)

*Continue to kit assembly*

### Jeep Grand Cherokee 2005-2007

1. Unsnap and remove panel from around radio including the vent on each side. (Figure A)
2. Remove (4) 7 mm screws securing radio to dash and remove radio. (Figure B)

*Continue to kit assembly*

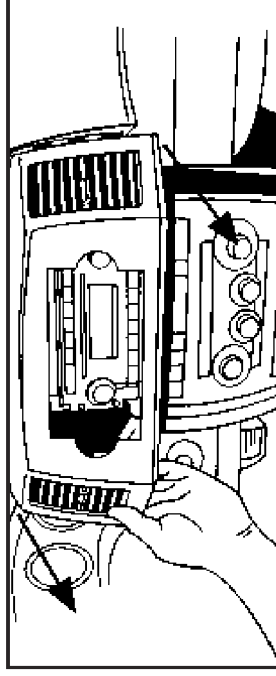

(Figure A)

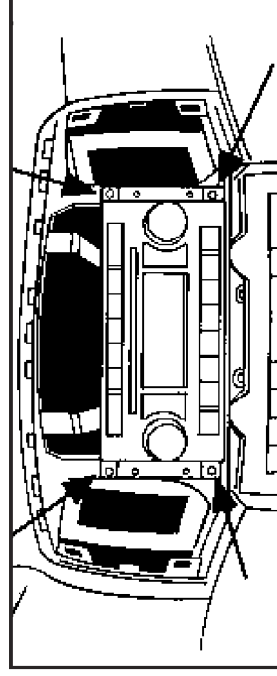

(Figure B)



## Dodge Caliber/Jeep Compass/ Patriot 2007-2008

1. Unsnap and move shifter trim to the side. (Figure A)
2. Unsnap and remove top center dash panel above A/C vents (Compass and Patriot only).
3. Unsnap center dash trim panel (do not remove until climate controls are removed). (Figure A)
4. Remove (4) Phillips screws holding climate control panel to backside of the center dash panel.
5. Remove (4) 7 mm screws securing radio. Unplug and remove radio.

*Continue to kit assembly*

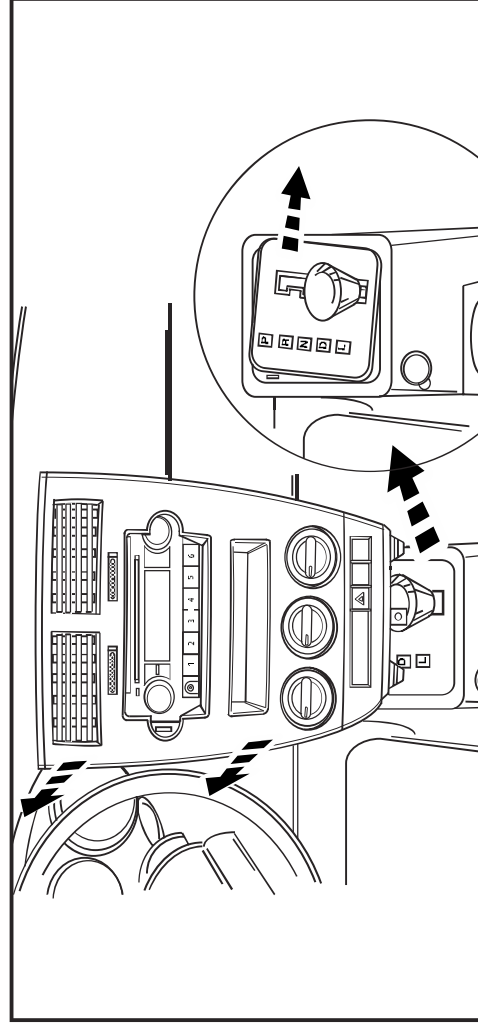

(Figure A)

## Jeep Commander 2006-2007

1. Remove the (16) screws securing the radio trim panel. (Figure A)
2. Unclip and remove the entire radio trim panel. (Figure B)
3. Remove (4) 7 mm screws securing radio to dash and remove radio.

*Continue to kit assembly*

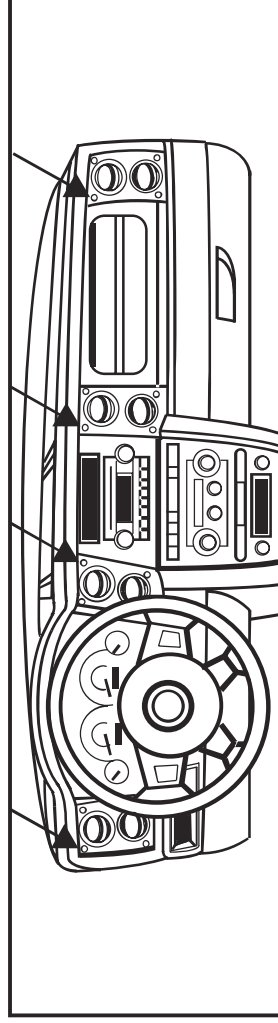

(Figure A)

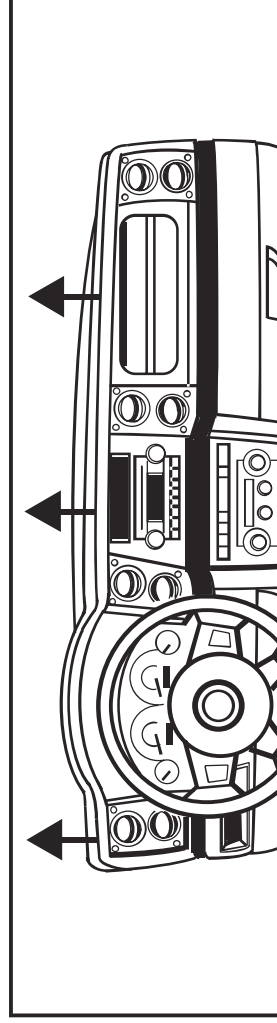

(Figure B)





Kit Assembly 99-6510

## DIN radio provision with pocket

1. Slide the DIN cage into the radio housing and secure by bending the metal locking tabs down. (Figure A)
2. Slide the aftermarket radio into the cage until secure. (Figure B)
3. Snap the pocket into the radio housing. (Figure C)
4. Locate the factory wiring harness in the dash. Metra recommends using the proper mating adapter from Metra or AXCESS. Re-connect the negative battery terminal and test the unit for proper operation.
5. Reassemble dash in reverse order of disassembly.

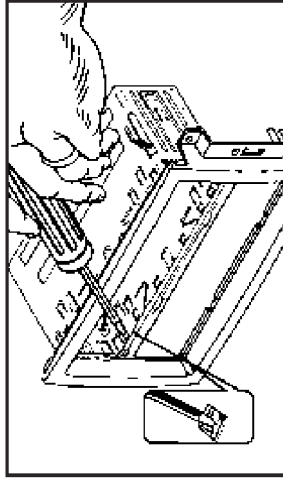

(Figure A)

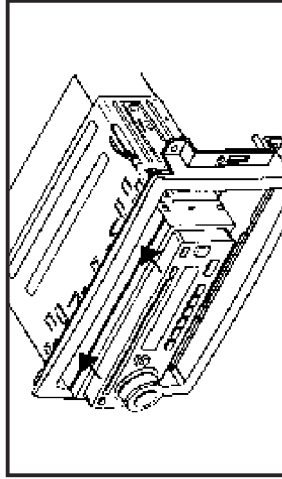

(Figure B)

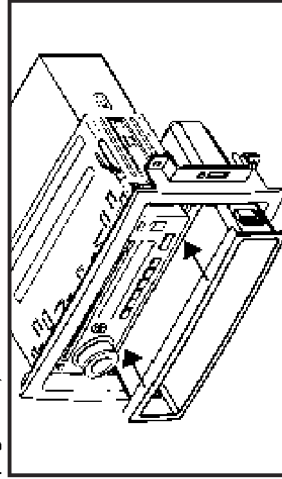

(Figure C)

## ISO radio provision with pocket

1. Mount the ISO Brackets to the radio with the screws supplied with the unit. (Figure A)
2. Slide the radio into the radio opening until the side clips engage. (Figure B)
3. Snap the ISO Trim Plate into the radio housing. (Figure C)
4. Snap the pocket into the radio housing. (Figure C)
5. Locate the factory wiring harness in the dash. Metra recommends using the proper mating adapter from Metra or AXCESS. Re-connect the negative battery terminal and test the unit for proper operation.
6. Reassemble dash in reverse order of disassembly.

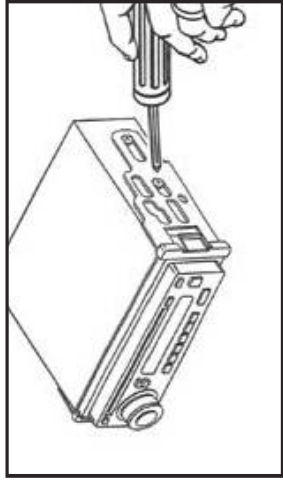

(Figure A)

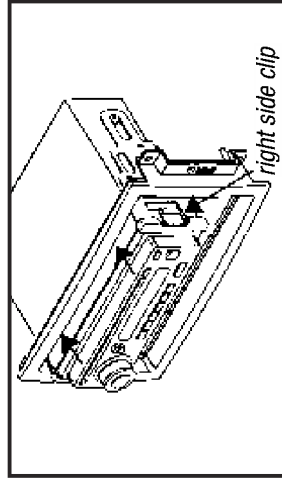

(Figure B)

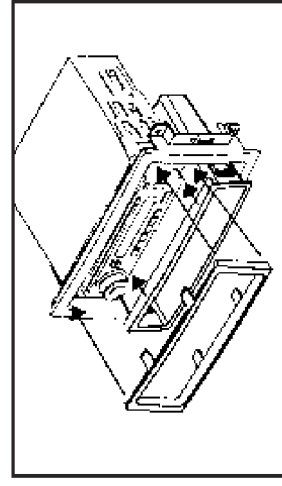

(Figure C)





Kit Assembly 99-6510

## Double DIN radio provision

1. Cut and remove center divider in radio housing. (Figure A)
2. Snap the DDIN brackets to the inside edge of the radio housing. (Figure B)
3. Slide the DDIN radio unit into the DDIN bracket/radio housing assembly and secure the radio unit to the kit using the screws supplied with the radio unit. (Figure C)
4. Snap the DDIN trim-plate onto the housing/radio assembly. (Figure D)
5. Locate the factory wiring harness in the dash. Metra recommends using the proper mating adapter from Metra or AXCESS. Re-connect the negative battery terminal and test the unit for proper operation.
6. Reassemble dash in reverse order of disassembly.

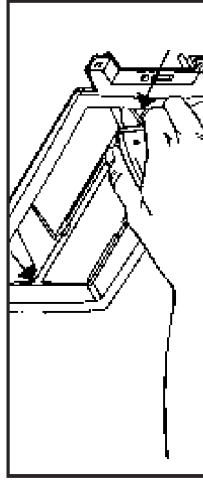

(Figure A)

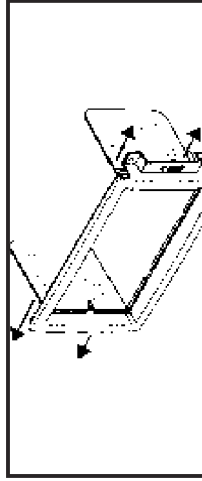

(Figure B)

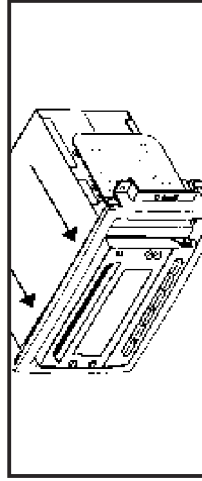

(Figure C)

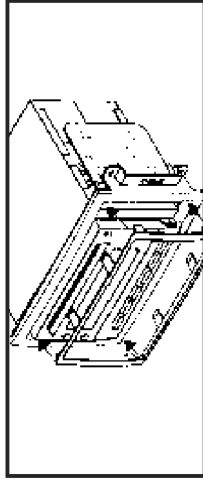

(Figure D)

## Stacked ISO unit provision

1. Cut and remove center divider in radio housing. (Figure A)
2. Snap the DDIN brackets to the inside edge of the radio housing. (Figure B)
3. Slide the stacked ISO DIN radio units into the DDIN bracket/radio housing assembly and secure the unit to the kit using the screws supplied with the units. (Figure C)
4. Snap the DDIN trim-plate onto the housing/radio assembly. (Figure D)
5. Locate the factory wiring harness in the dash. Metra recommends using the proper mating adapter from Metra or AXCESS. Re-connect the negative battery terminal and test the unit for proper operation.
6. Reassemble dash in reverse order of disassembly.

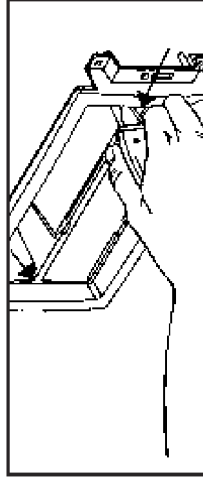

(Figure A)

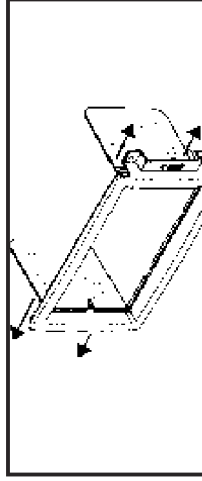

(Figure B)

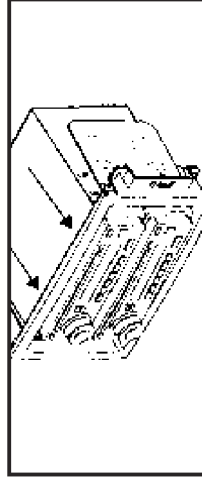

(Figure C)



(Figure D)







**INSTALLATION INSTRUCTIONS FOR PART 999-6510**

REV. 9/18/2013 INST99-6510



**KNOWLEDGE IS POWER**  
Enhance your installation and fabrication skills by enrolling in the most recognized and respected mobile electronics school in our industry. Log onto [www.installerinstitute.com](http://www.installerinstitute.com) or call 800-354-6782 for more information and take steps toward a better tomorrow.

**Metra recommends MECP certified technicians**

**metraonline.com**

**1-800-221-0932**

**METRA. The World's best kits.<sup>TM</sup>**

© COPYRIGHT 2004-2011 METRA ELECTRONICS CORPORATION